

Everything you always wanted
to know about Deep Learning,
but were afraid to ask

Mestrado em Informática Médica

Francesco Renna

Outline

- What is deep learning?
- Artificial neural networks
- Convolutional neural networks
- Biomedical application examples
 - Image classification
 - Image segmentation
 - Image reconstruction
- Application challenges

Outline

- **What is deep learning?**
- Artificial neural networks
- Convolutional neural networks
- Biomedical application examples
 - Image classification
 - Image segmentation
 - Image reconstruction
- Application challenges

Deep learning: did you hear about that?

- Google image recognition
- Facebook face recognition
- Google translator
- DeepMind AlphaGo player
- Netflix, Amazon, Spotify recommendation engines
- Image colorization
- Image caption generation
- Sentiment analysis
- Etc...

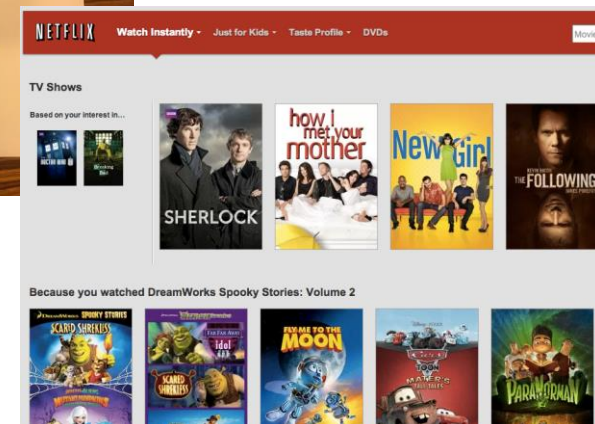

What is deep learning?

- It is a specific area of machine learning
 - Supervised learning
 - Unsupervised learning
 - Reinforcement learning
- Idea (supervised learning): learn how to make decisions, perform a task, from examples



dog



cat

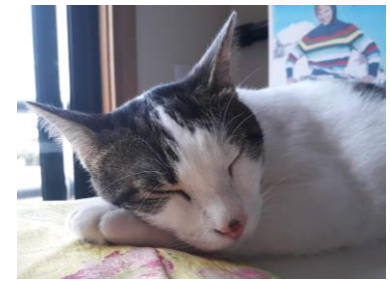

dog or cat?

How to extract information from the raw data?

Sensor

Acquire the data, observations to be classified or described



Feature Extraction

Compute numeric or symbolic information starting from the data:
e.g., color, shape, texture, etc.



Classifier

Classify or describe the observation, relying on the extracted features

More specifically

- Deep learning refers to a class of learning algorithms
- They are based on the use of a specific kind of classifiers: neural networks (NNs)

Outline

- What is deep learning?
- **Artificial neural networks**
- Convolutional neural networks
- Biomedical application examples
 - Image classification
 - Image segmentation
 - Image reconstruction
- Application challenges

Biological Neural Networks

- **Neuroscience:**
 - Population of physically inter-connected neurons.
- **Includes:**
 - Biological **Neurons**
 - Connecting **Synapses**
- **The human brain:**
 - 100 billion neurons
 - 100 trillion synapses

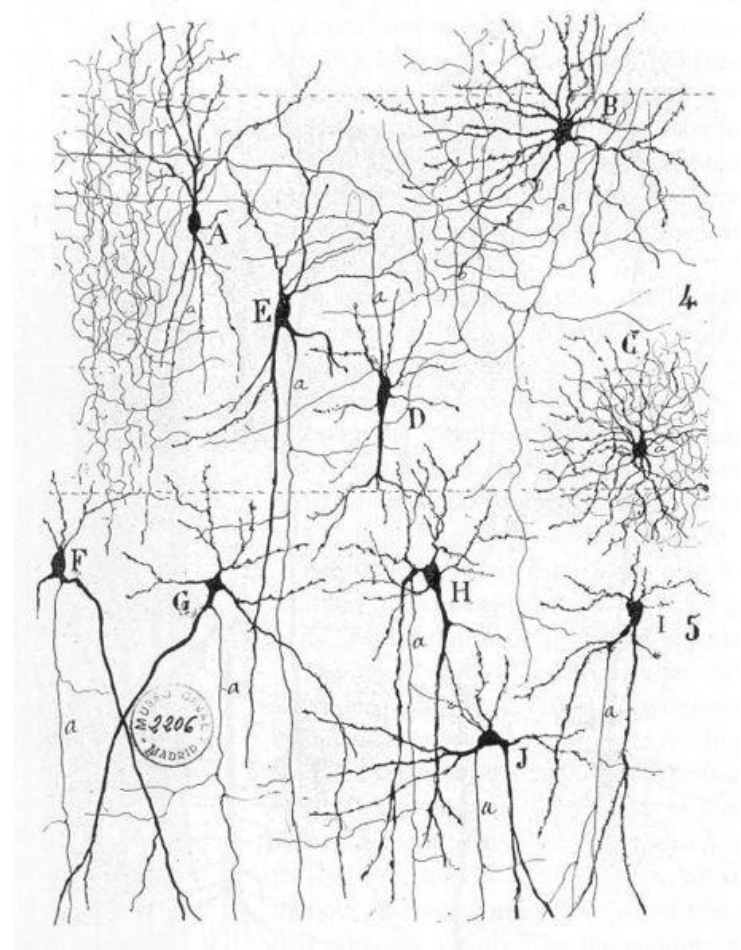

Biological Neuron

- **Neurons:**
 - Have K inputs (*dendrites*).
 - Have 1 output (*axon*).
 - If the sum of the input signals surpasses a *threshold*, sends an *action potential* to the axon.
- **Synapses**
 - Transmit electrical signals between neurons.

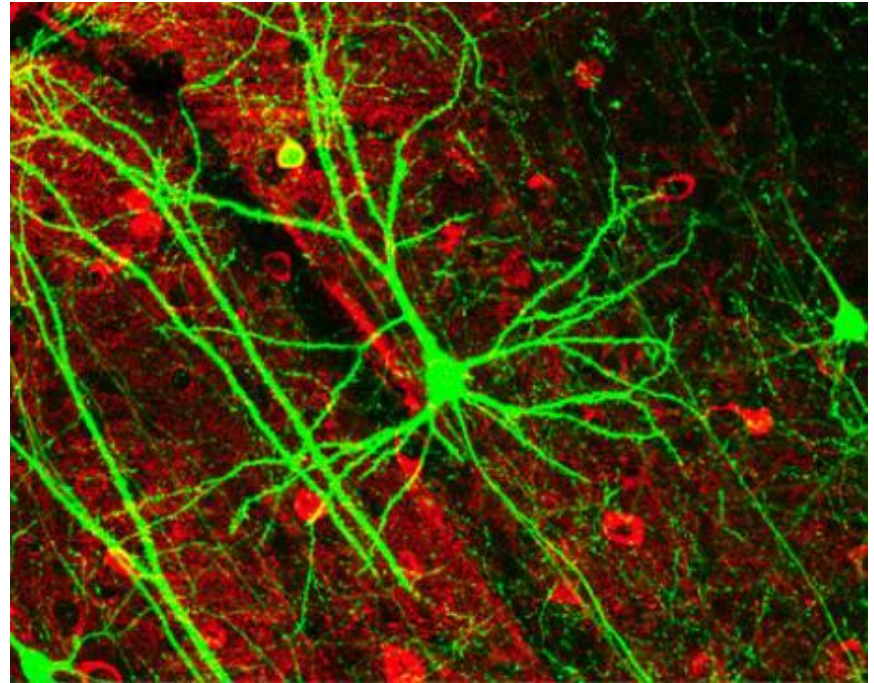

Artificial Neuron

- Also called the **McCulloch-Pitts neuron**.
- Passes a **weighted sum of inputs**, to an **activation function**, which produces an **output value**.

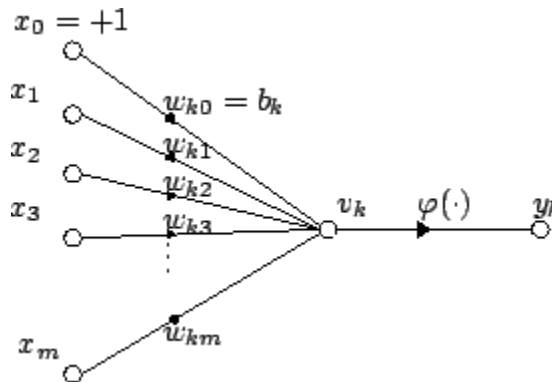

$$y_k = \varphi \left(\sum_{j=0}^m w_{kj} x_j \right)$$

Sample activation functions

- Rectified Linear Unit (ReLU)

$$y = \begin{cases} u, & \text{if } u \geq 0 \\ 0, & \text{if } u < 0 \end{cases}, \quad u = \sum_{i=1}^n w_i x_i$$

- Sigmoid function

$$y = \frac{1}{1 + e^{-u}}$$

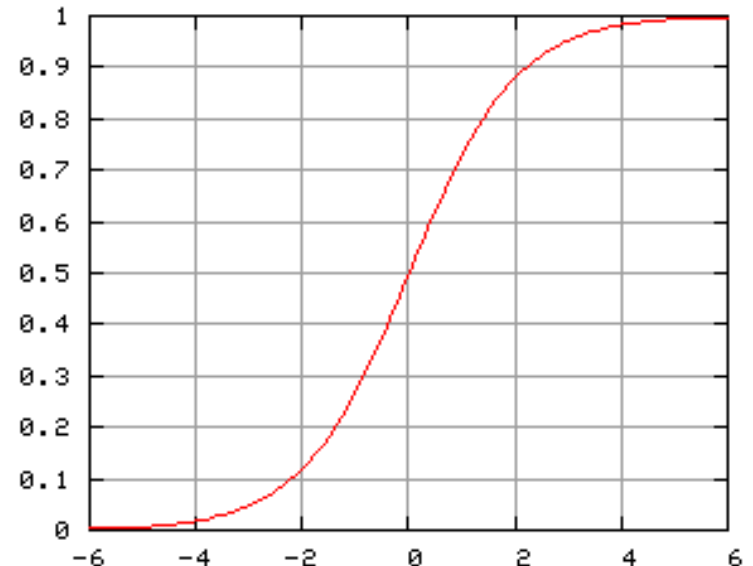

Artificial Neural Network

- Commonly referred as **Neural Network**.
- Basic principles:
 - One neuron can perform a simple decision.
 - Many **connected** neurons can make more **complex decisions**.

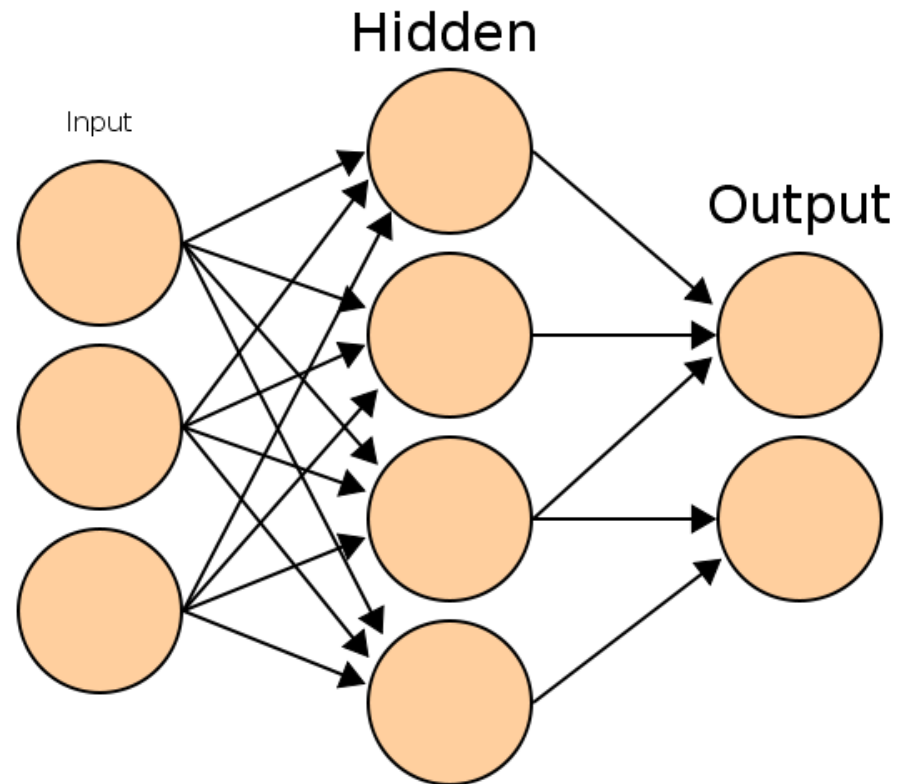

Characteristics of a NN

- **Network configuration**
 - How are the neurons inter-connected?
 - We typically use *layers* of neurons (input, output, hidden).
- **Individual neuron parameters**
 - Weights associated with inputs.
 - Activation function.
 - Decision *thresholds*.

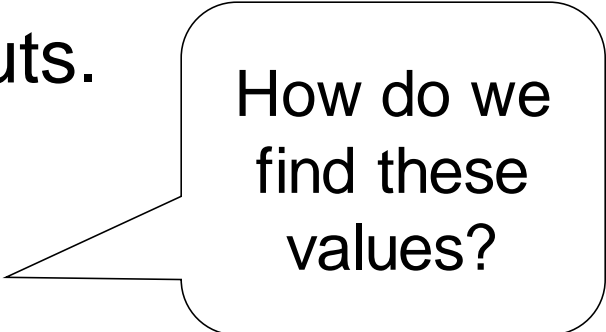

How do we find these values?

Learning paradigms

- We can define the network configuration.
- How do we define neuron ***weights*** and ***decision thresholds***?
 - **Learning** step.
 - We **train** the NN to classify what we want.
 - (Supervised learning): We need to have access to a set of training data for which we know the correct class/answer

Learning

- We want to obtain an **optimal solution** given a set of **observations**.
- A **cost function** measures how close our solution is to the **optimal solution**.
- Objective of our learning step:
 - Minimize the **cost function**.



Backpropagation
Algorithm

In formulas

Network output: $\text{Out}(x) = \varphi\left(\sum_m w_{nm}^{(L)} \varphi\left(\dots \varphi\left(\sum_j w_{lj}^{(2)} \varphi\left(\sum_k w_{jk}^{(1)} x_k\right)\right)\right)\right)$

Training set: $\{(x_i, y_i)\}_{i=1, \dots, N}$

input \swarrow
label \swarrow

Optimization: find $[w_{jk}^{(1)}, w_{lj}^{(2)}, \dots, w_{nm}^{(L)}]$ **such that**

$$\text{minimize } \sum_{i=1}^N \text{Loss}(\text{Out}(x_i), y_i)$$

It is solved with (variants of) the gradient descent, where gradients are computed via the backpropagation algorithm

Warnings!

- Is the NN too simple for the data?
 - Underfitting: cannot capture data behavior
- Is the NN too complex for the data?
 - Overfitting: fit perfectly training data, but will not generalize well on unseen data

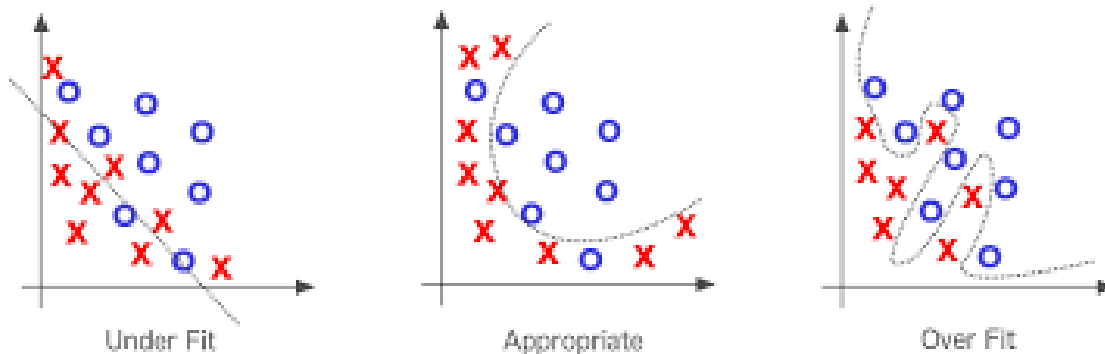

Feedforward neural network

- Simplest type of NN.
- Has no *cycles*.
- Input layer
 - Need as many neurons as coefficients of my *feature vector*.
- Hidden layers.
- Output layer
 - Classification results.

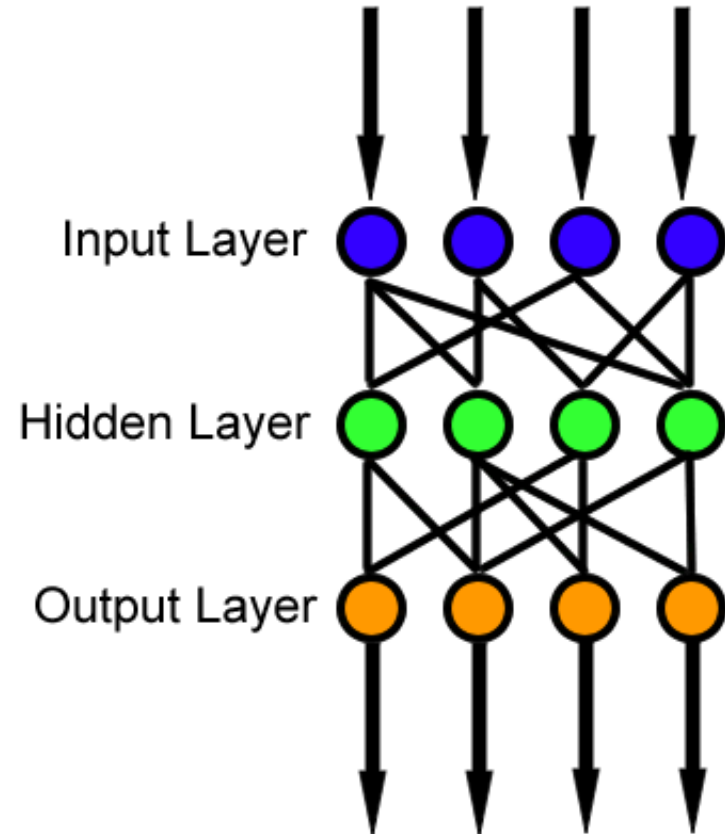

Deep learning = Deep neural networks

- Deep = high number of hidden layers
 - Learn a larger number of parameters!
- It has been recently (~ in the last 6 years) possible since we have:
 - Access to big amounts of (training) data
 - Increased computational capabilities (e.g., GPUs)

Outline

- What is deep learning?
- Artificial neural networks
- **Convolutional neural networks**
- Biomedical application examples
 - Image classification
 - Image segmentation
 - Image reconstruction
- Application challenges

Convolutional neural networks (CNNs)

- Feedforward neural networks
- Weight multiplications are replaced by convolutions (filters)
- **Change of paradigm:** can be directly applied to the raw signal, without computing first *ad hoc* features
- Features are learnt automatically!!

End-to-end learning

Sensor

Acquire the data, observations to be classified or described



Convolutional neural network

Classify or describe the observation, automatically extracting (learnt) features

Convolution

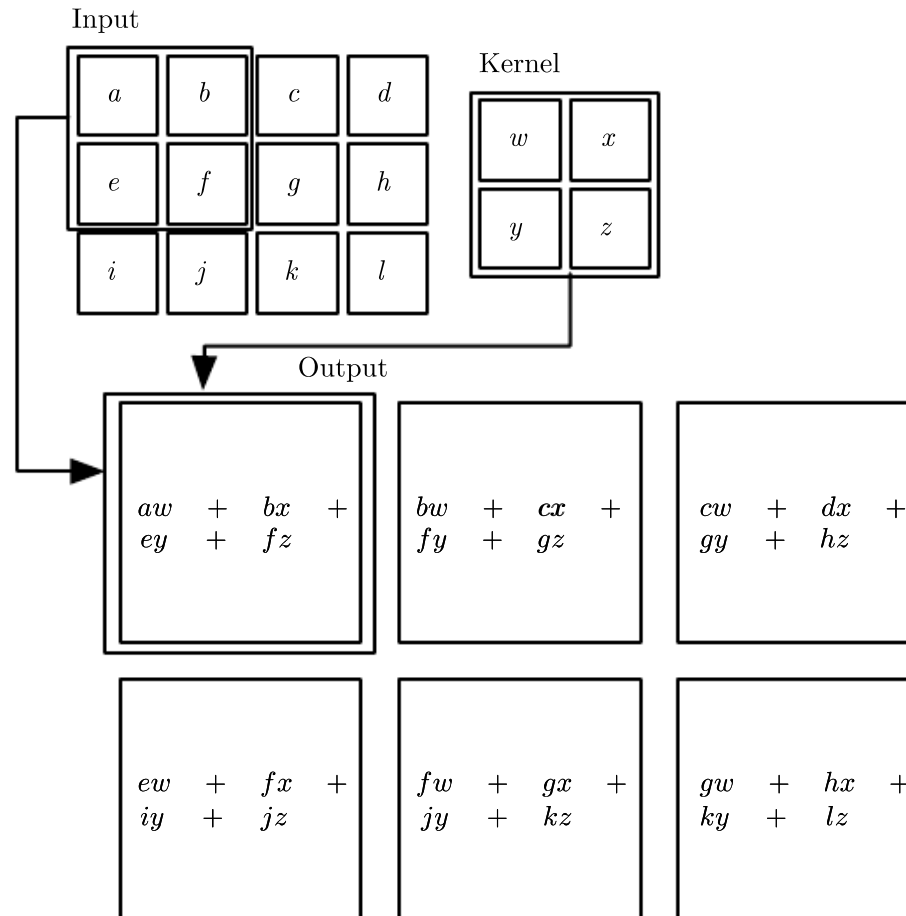

CNN example

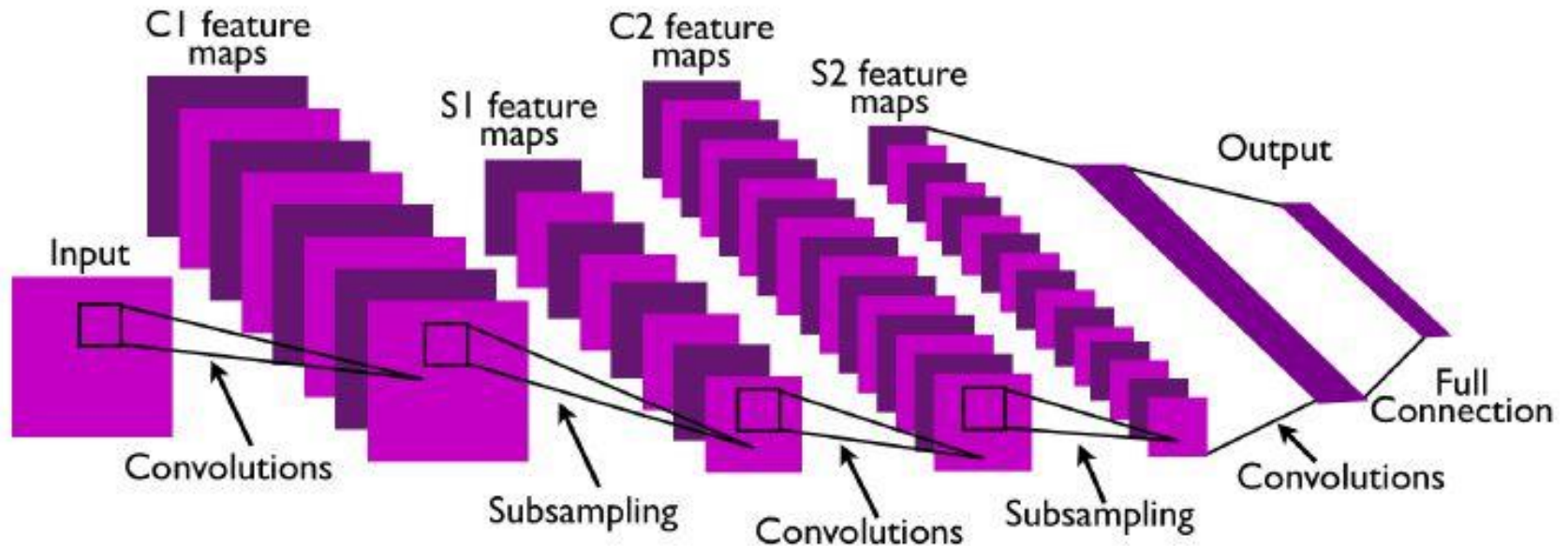

- Convolutional layers, followed by nonlinear activation and subsampling
- Output of hidden layers (feature maps) = features learnt by the CNN
- Before classification, fully connected layers (as in “standard” NN)

Automatically learnt features

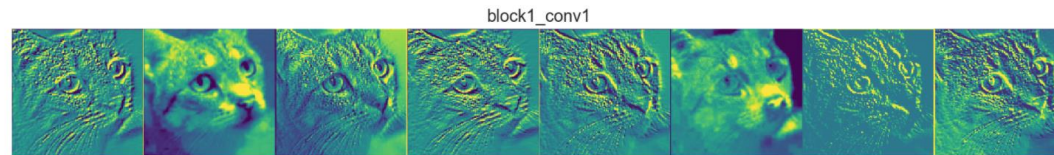

Retain most information (edge detectors)

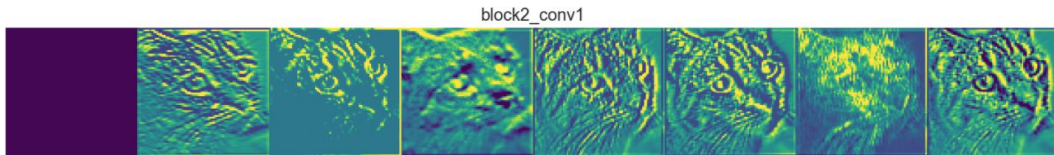

Towards more abstract representation

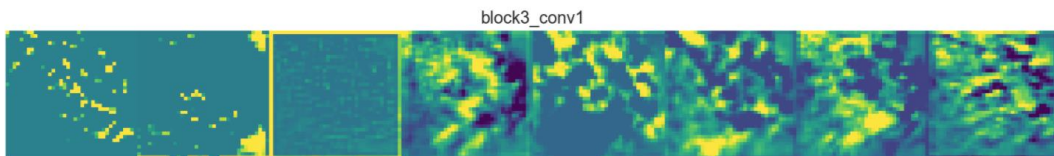

Encode high level concepts

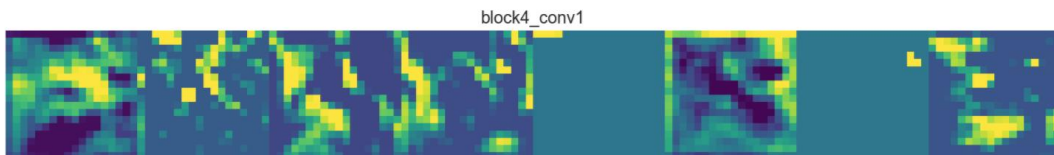

Sparser representations:
Detect less (more abstract) features

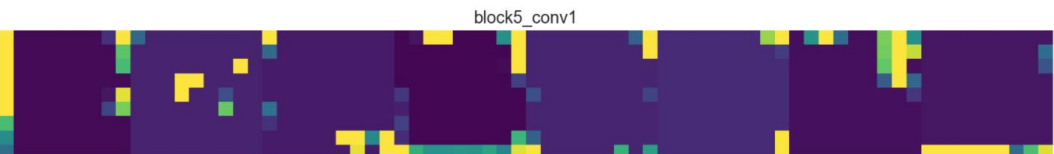

CNN - Properties

- Reduced amount of parameters to learn (local features)
- More efficient than dense multiplication
- Specifically thought for images or data with grid-like topology
- Convolutional layers are equivariant to translation (useful for classification!)
- Currently state-of-the-art in several tasks

Outline

- What is deep learning?
- Artificial neural networks
- Convolutional neural networks
- **Biomedical application examples**
 - Image classification
 - Image segmentation
 - Image reconstruction
- Application challenges

Image/signal classification

- Objective: given an image/signal, produce a label
- Computer Aided Decision (CAD) systems:
 - Help human operator in taking decision
 - Continuous monitoring
 - Screening:
 - Reduce number of unnecessary exams
 - Reduce number of missed detections

Successful biomedical application

- Diabetic retinopathy detection
- Tumor detection from MRI, CT, X-rays, etc
- Skin lesion classification from clinical and dermoscopic images
- Heart sound classification: normal vs. abnormal, murmur classification
- Parkinson's disease detection from voice recording

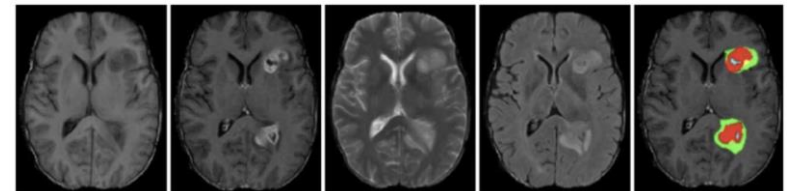

AlexNet

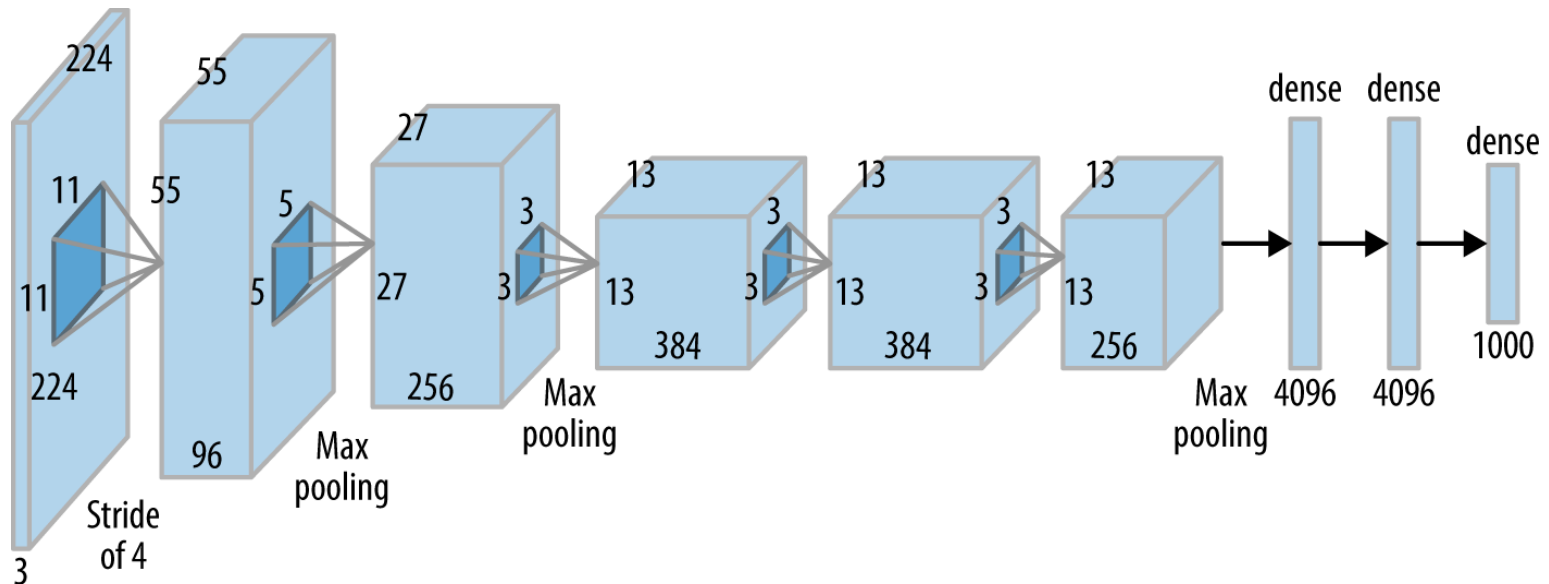

- Winner of ILSVRC 2012
- Marked the beginning of recent deep learning revolution

VGG-16

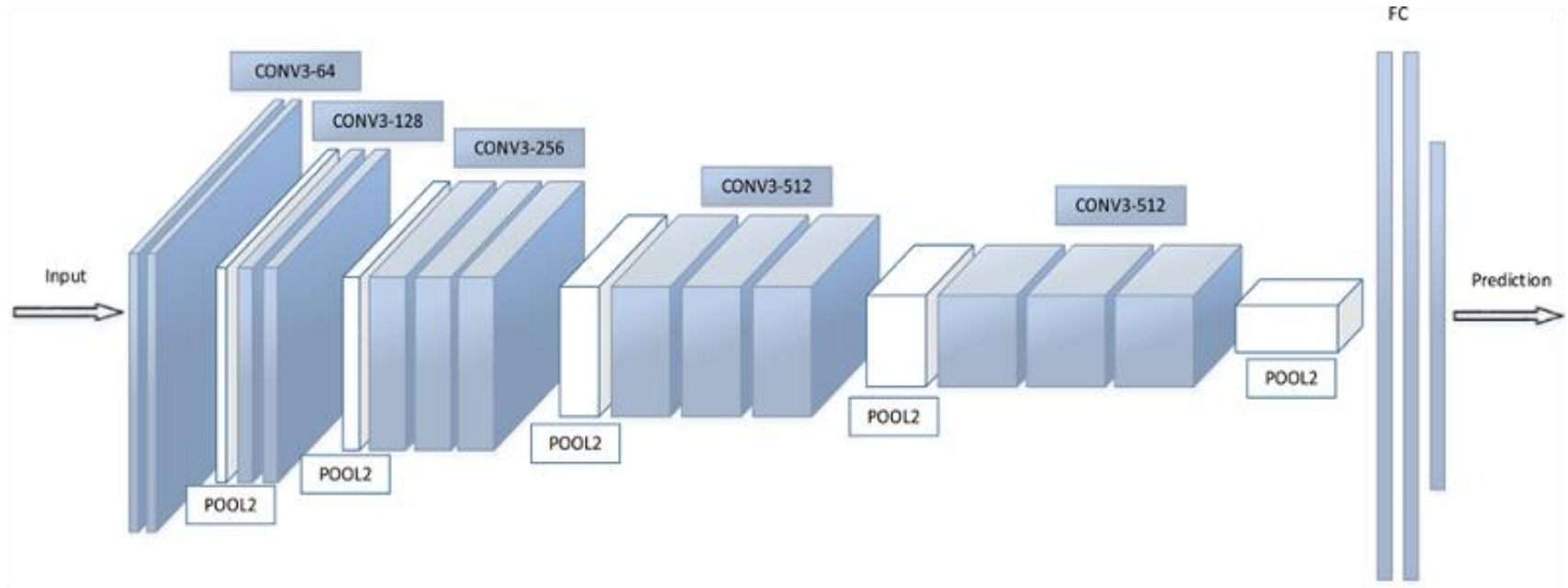

- Very small filters (3x3)
- Deeper than AlexNet: 16 layers

ResNet

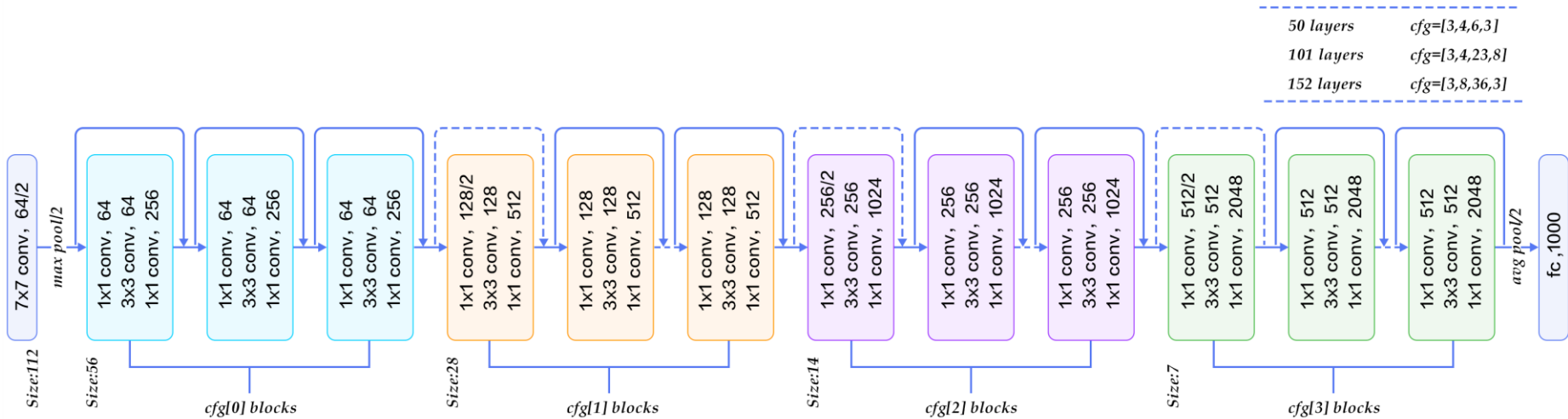

From: <https://www.codeproject.com/Articles/1248963/Deep-Learning-using-Python-plus-Keras-Chapter-Re>

- Increase the number of layers by introducing a residual connection
- Blocks are actually learning residual functions: easier!

Image/signal semantic segmentation

- Objective: partition an image/signal in multiple segments, sets of pixels/samples
- Similar to classification, but a label is assigned to each pixel of the image
- Used for understanding and interpretation:
 - Highlight region of interest
 - Compute volume
 - Surgery planning

Successful biomedical applications

- MRI tumor segmentation
- X-Ray image segmentation
- Electron and light microscopy segmentation
- Heart sound segmentation
- Etc.

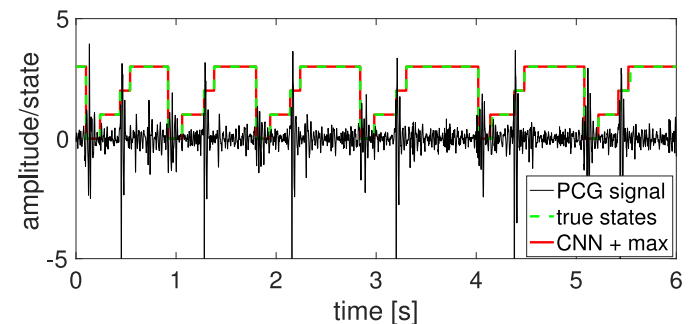
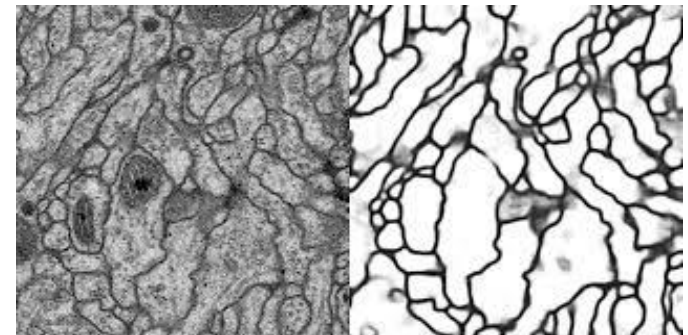
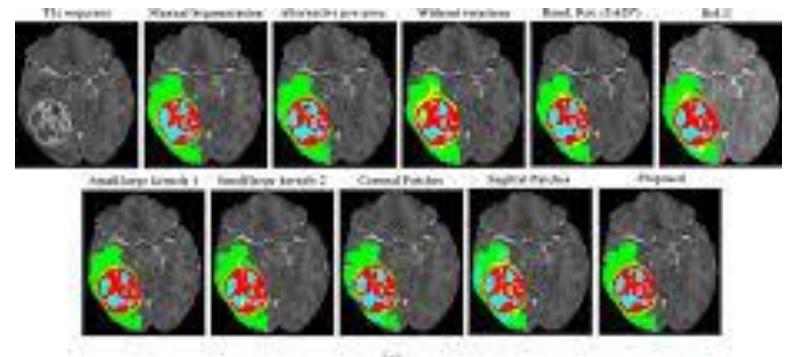

U-Net

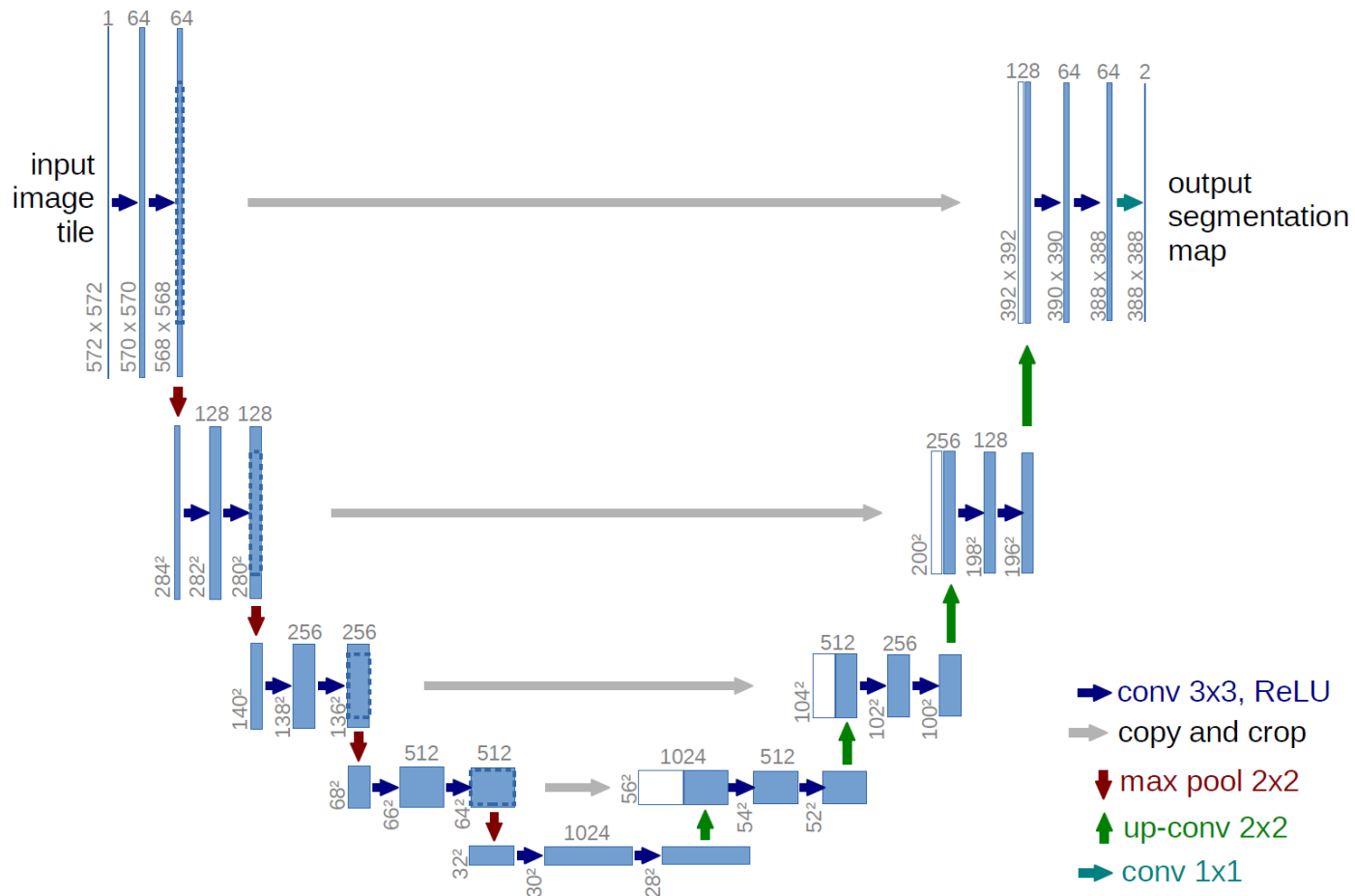

- Encoder-decoder structure

O. Ronneberger, P. Fischer, and T. Brox. "U-net: Convolutional networks for biomedical image segmentation." In *International Conference on Medical image computing and computer-assisted intervention*, pp. 234-241. Springer, Cham, 2015.

Image reconstruction/acquisition

- Recover a full image of interest from partial measurements/observations
- Increase de quality/resolution of acquired image
- Reduce the impact of reconstruction artifacts
- Reduce acquisition time/dose

Example: Computer Tomography

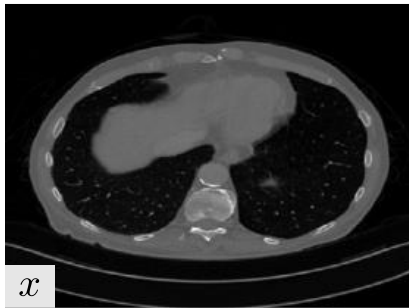

Fully sampled image

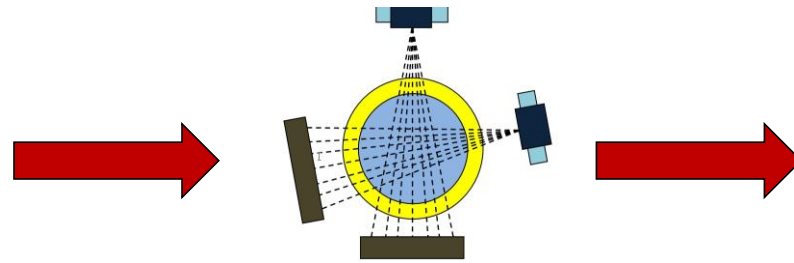

CT measurements

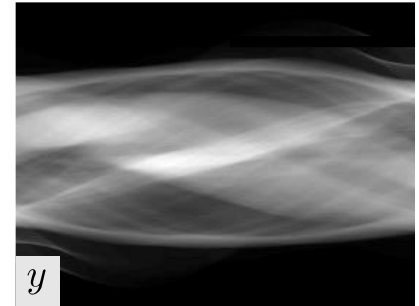

Sinogram

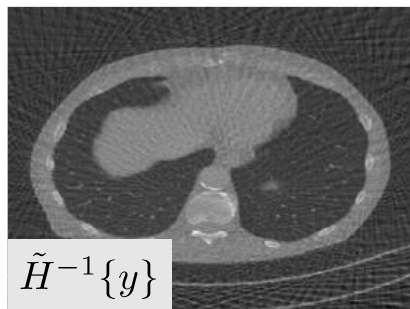

Direct reconstruction
from downsampled sinogram

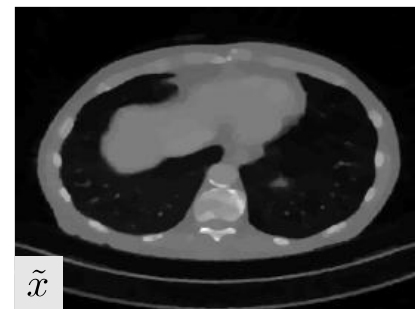

Reconstruction with CNN

Remarks

- It is a regression problem, not a classification problem
 - The CNN output is not a class label, but a collection of real numbers (the recovered image)
- Loss function: usually different from classification problems (e.g., L2-norm, in space or frequency domain)
- Training set: pairs of ground truth images (fully sampled) and downsampled measurements

Modified U-Net

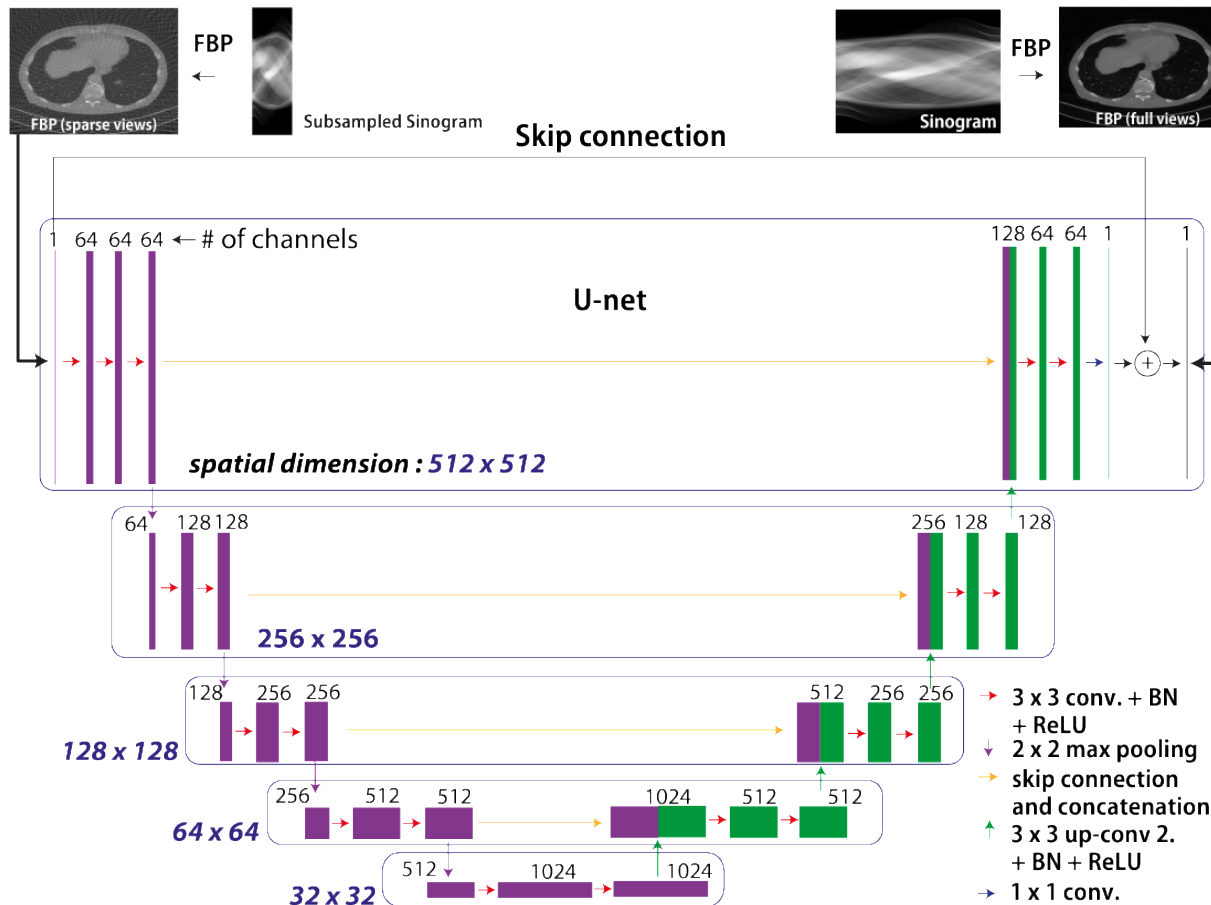

Application challenges

- **Great results! But...**
 - Difficult to select best architecture for a problem
 - Require new training for each task/configuration
 - (Most commonly) require a large training dataset to generalize well
 - Data augmentation, weight regularization, transfer learning, etc.
 - Still not fully understood why it works so well
 - Robustness against adversarial examples
 - Approval from government agencies (ex. FDA)?

To know more...

- **Theory**

- I. Goodfellow, Y. Bengio, and A. Courville. Deep learning. Vol. 1. Cambridge: MIT press, 2016. (<https://www.deeplearningbook.org/>)

- **Survey papers**

- "Deep Learning for Visual Understanding," in IEEE Signal Processing Magazine, vol. 34, no. 6, Nov. 2017.
- A. Lucas, M. Iliadis, R. Molina and A. K. Katsaggelos, "Using Deep Neural Networks for Inverse Problems in Imaging: Beyond Analytical Methods," in IEEE Signal Processing Magazine, vol. 35, no. 1, pp. 20-36, Jan. 2018.

- **Tutorial**

- Oxford Visual Geometry Group: VGG Convolutional Neural Networks Practical (<http://www.robots.ox.ac.uk/~vgg/practicals/cnn/>)

To start coding

- **Coding frameworks for deep learning**
 - TensorFlow (<https://www.tensorflow.org/>),
PyTorch (<https://pytorch.org/>),
Theano (<http://deeplearning.net/software/theano/>),
MatConNet (<http://www.vlfeat.org/matconvnet/>),
etc.
- **High-level wrappers**
 - Keras (<https://keras.io/>),
TensorLayer (<https://tensorlayer.readthedocs.io/en/stable/>),
Lasagne (<https://lasagne.readthedocs.io/en/latest/>),
etc.
- **GPU strongly recommended!**

Thank you!

frarena@dcc.fc.up.pt