

VC 13/14 – T2

Image Formation

Mestrado em Ciência de Computadores
Mestrado Integrado em Engenharia de Redes e
Sistemas Informáticos

Miguel Tavares Coimbra

Outline

- ‘Computer Vision’?
- The Human Visual System
- Image Capturing Systems

Acknowledgements: Most of this course is based on the excellent courses offered by Prof. Shree Nayar at Columbia University, USA and by Prof. Srinivasa Narasimhan at CMU, USA. Please acknowledge the original source when reusing these slides for academic purposes.

Topic: Computer Vision?

- 'Computer Vision'?
- The Human Visual System
- Image Capturing Systems

Computer Vision

“The goal of **Computer Vision** is to make useful decisions about real physical objects and scenes based on sensed images”,

Shapiro and Stockman, “Computer Vision”, 2001



Components of a Computer Vision System

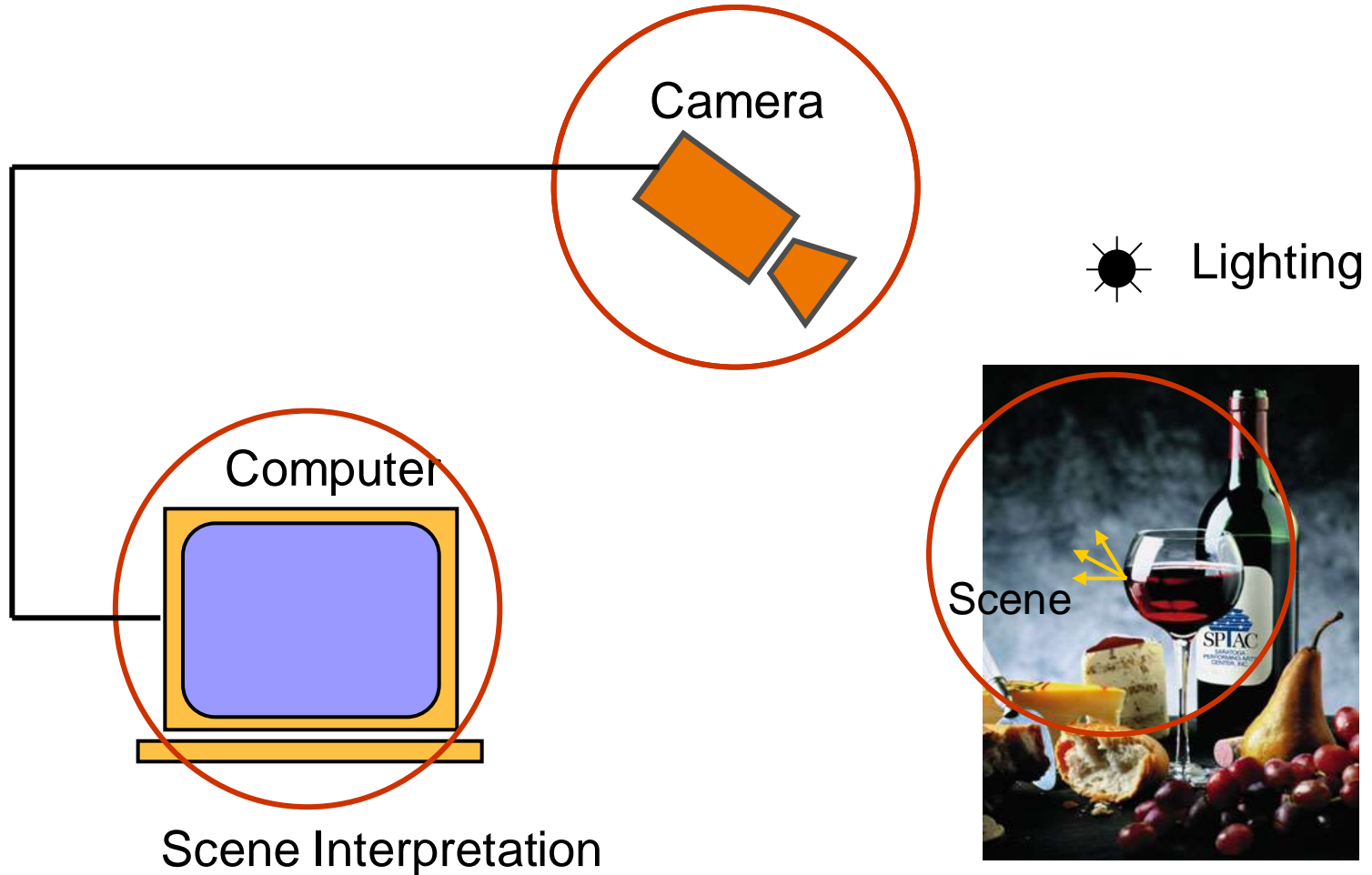

Topic: The Human Visual System

- 'Computer Vision'?
- **The Human Visual System**
- Image Capturing Systems

Our Eyes

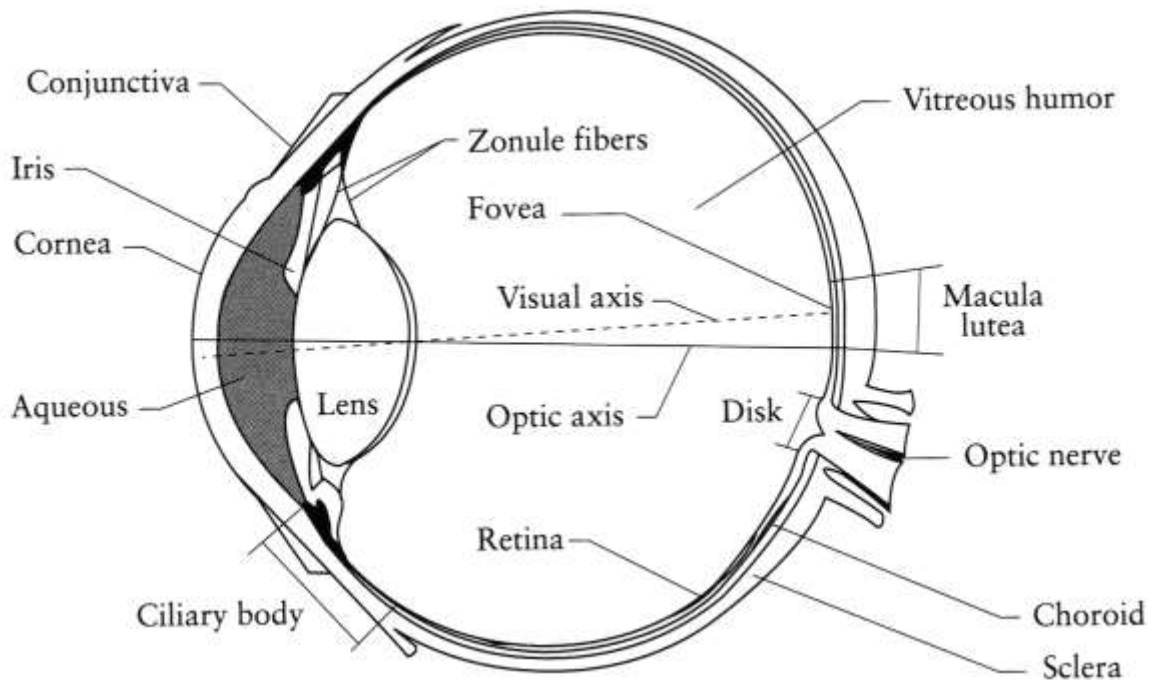
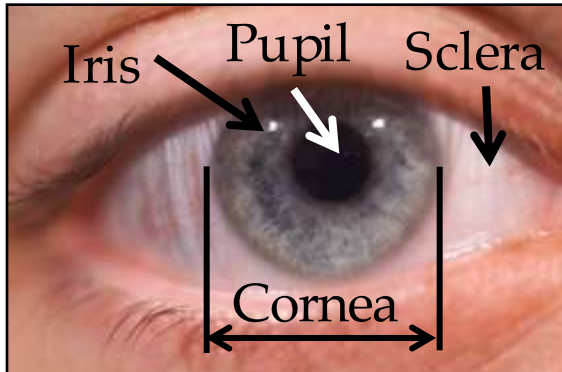

- Iris is the diaphragm that changes the aperture (pupil)
- Retina is the sensor where the fovea has the highest resolution

Focusing

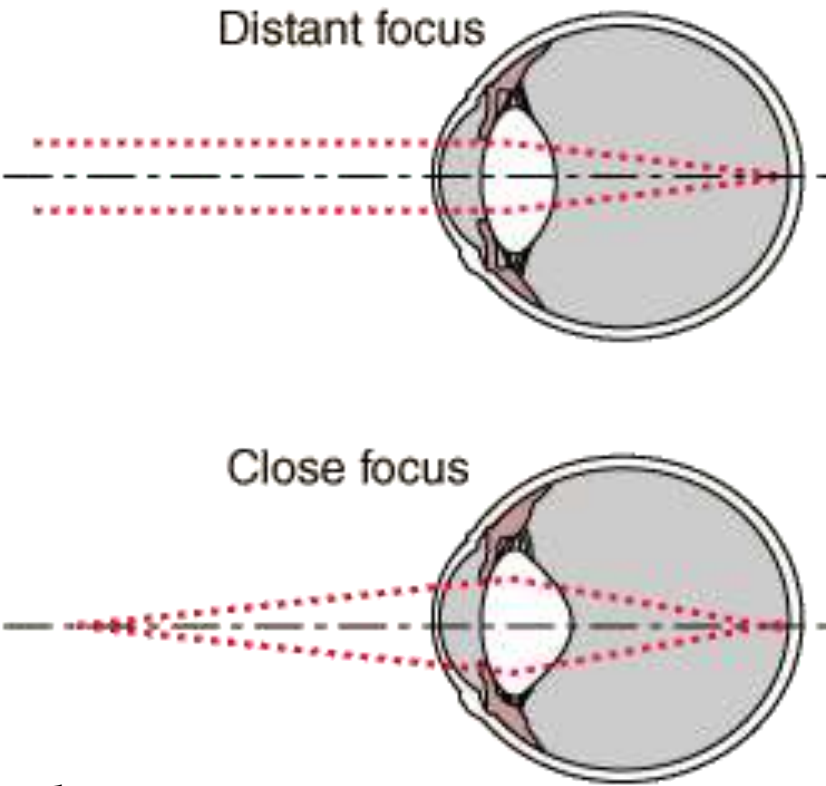
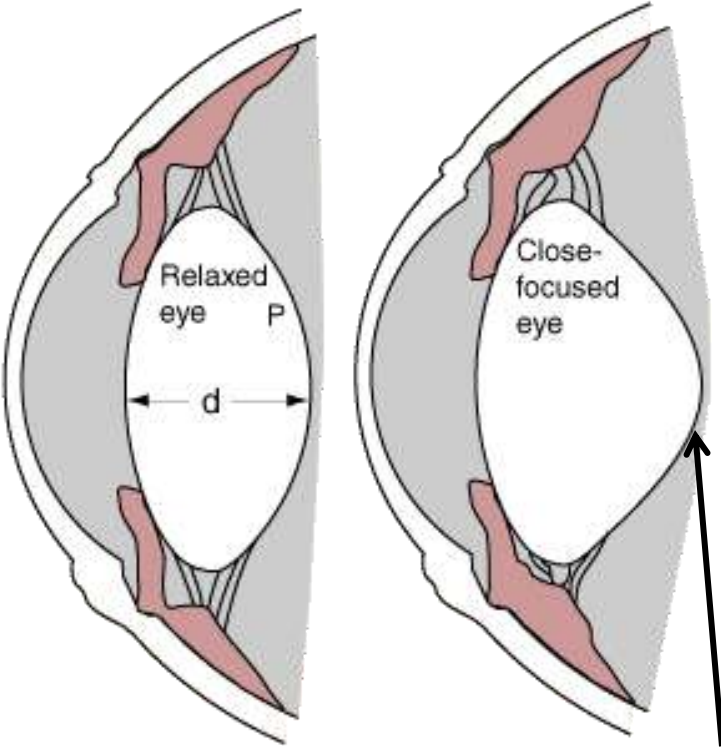

shorter focal length

Changes the focal length of the lens

Myopia and Hyperopia

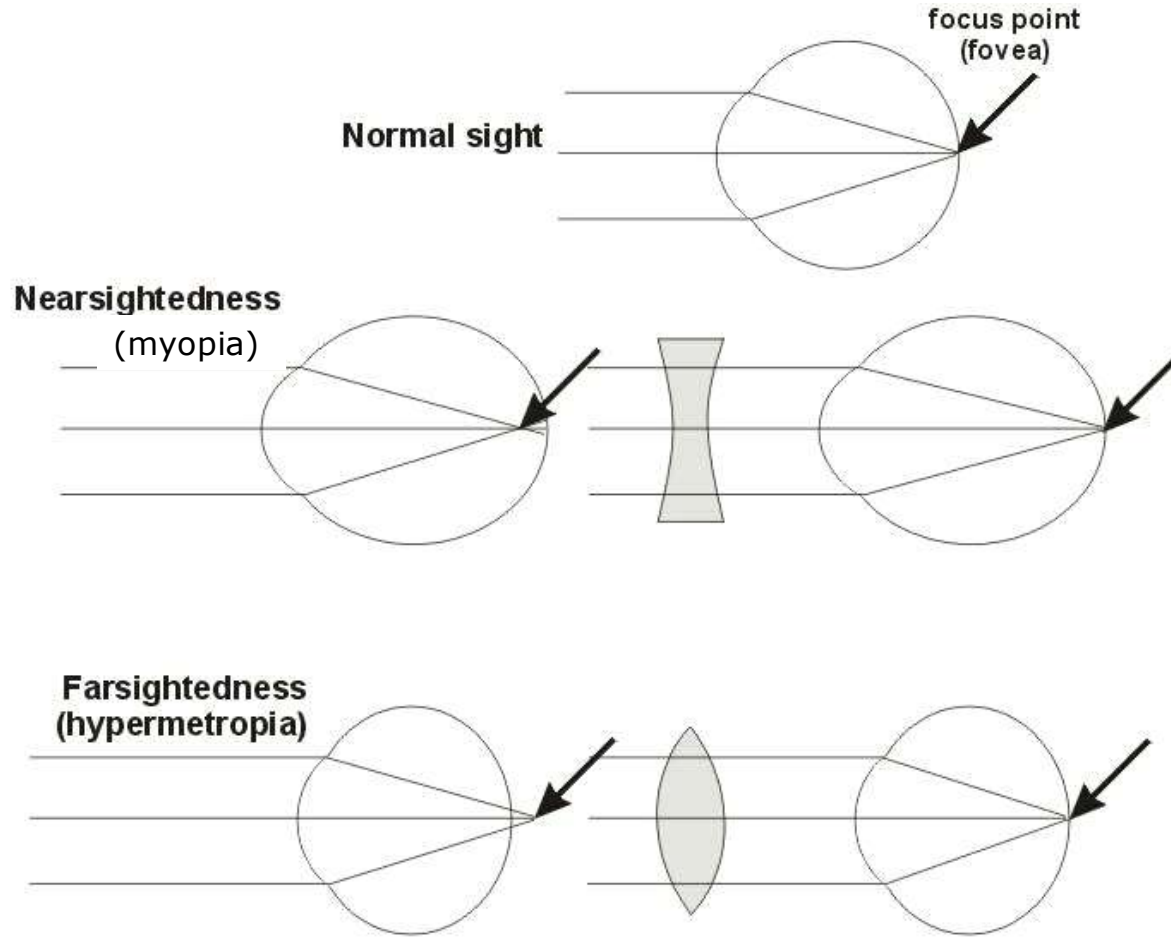

Astigmatism

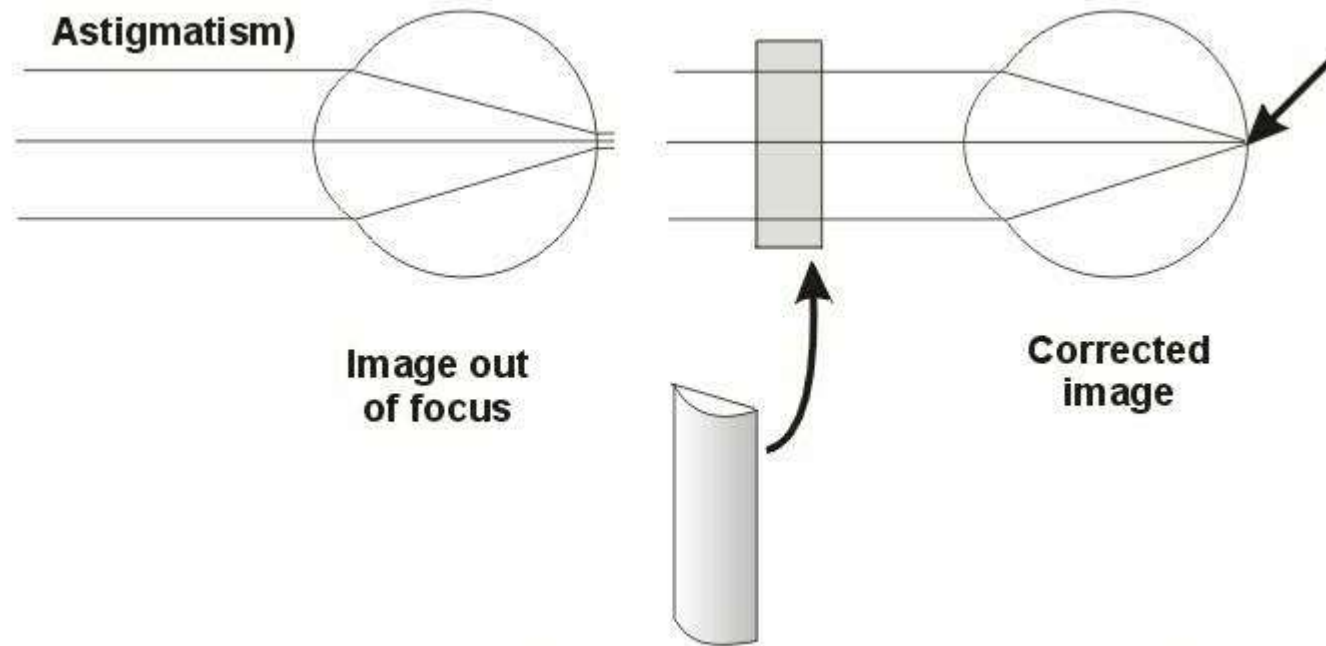

The cornea is distorted causing images to be un-focused on the retina.

Blind Spot in the Eye



Close your right eye and look directly at the “+”

Colour

- **Our retina has:**
 - **Cones** – Measure the frequency of light (colour)
 - 6 to 7 millions
 - High-definition
 - Need high luminosity
 - **Rods** – Measure the intensity of light (luminance)
 - 75 to 150 millions
 - Low-definition
 - Function with low luminosity

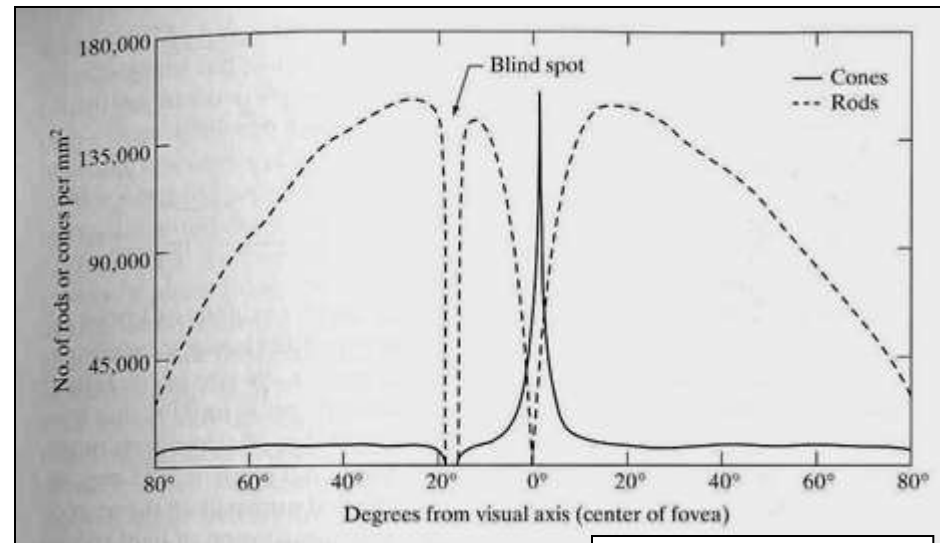

Gonzalez & Woods

We only see colour in the center of our retina!

Topic: Image Capturing Systems

- 'Computer Vision'?
- The Human Visual System
- **Image Capturing Systems**

A Brief History of Images

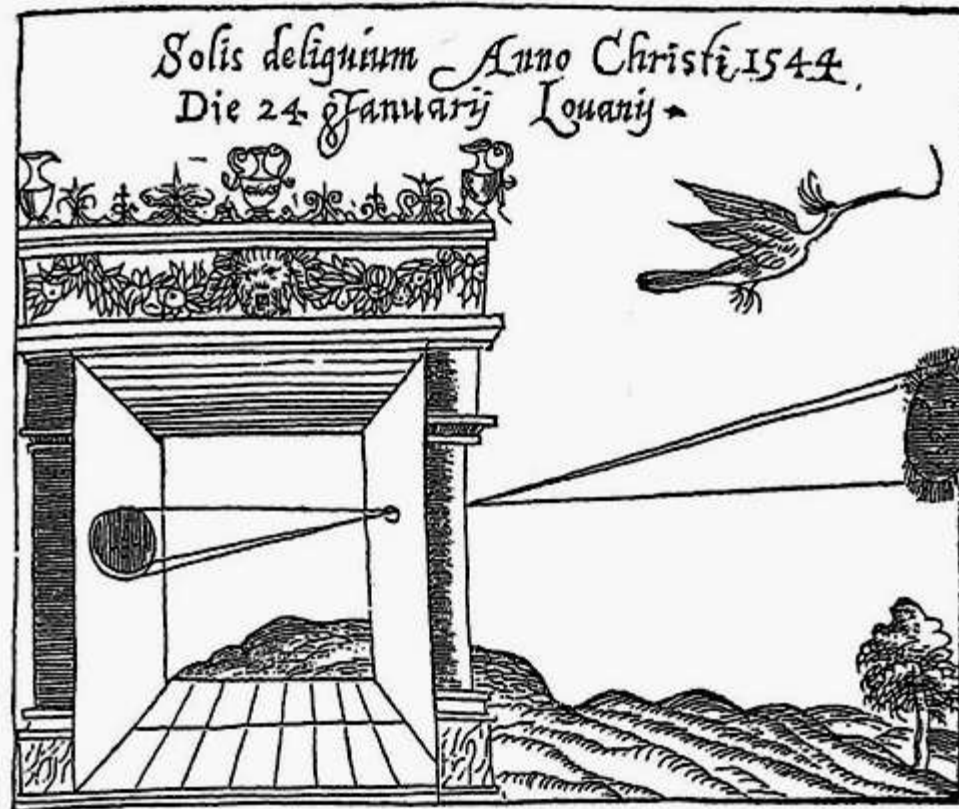

1544

Camera Obscura, Gemma Frisius, 1544

A Brief History of Images

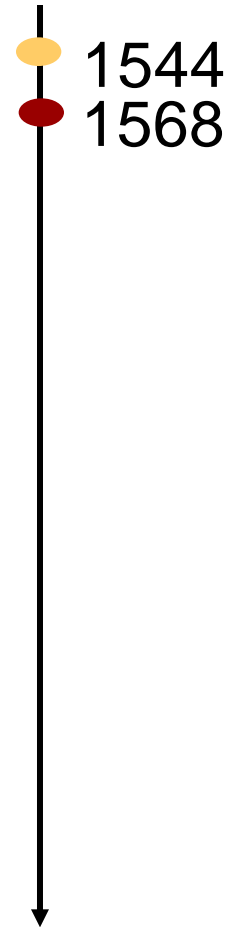
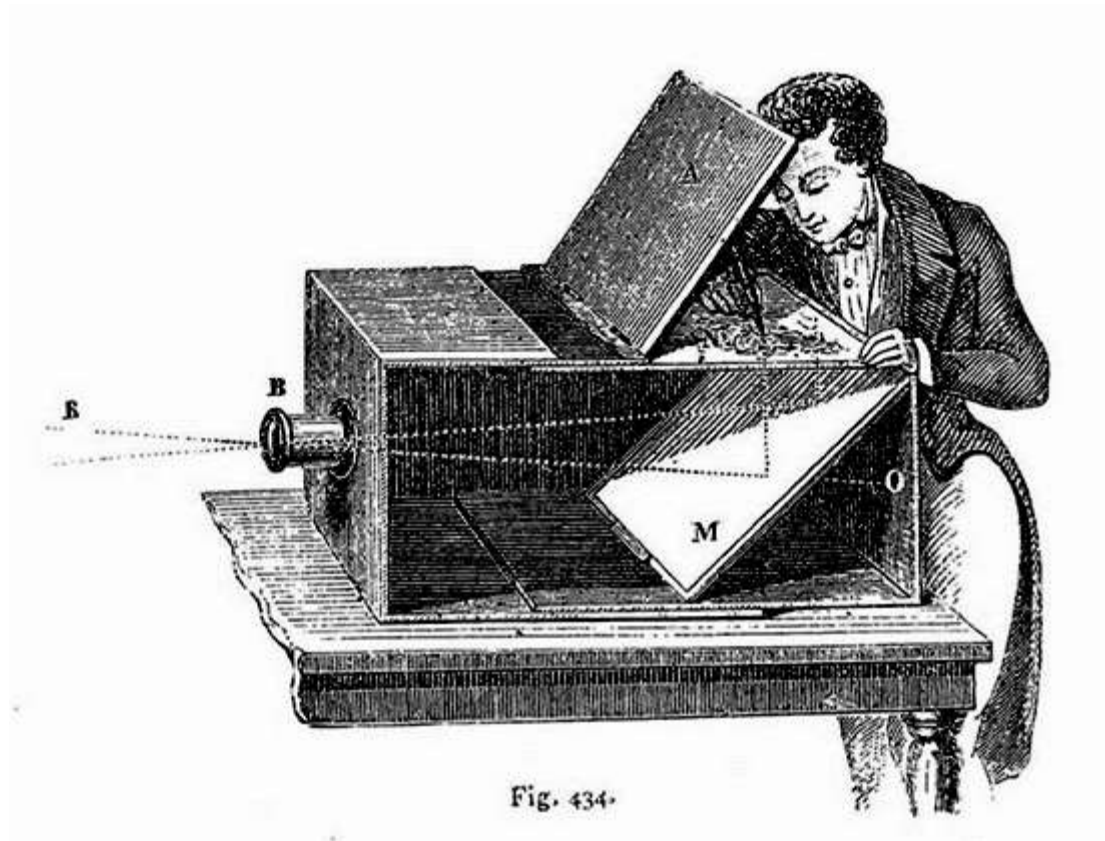

Lens Based Camera Obscura, 1568

A Brief History of Images



Still Life, Louis Jaques Mande Daguerre, 1837

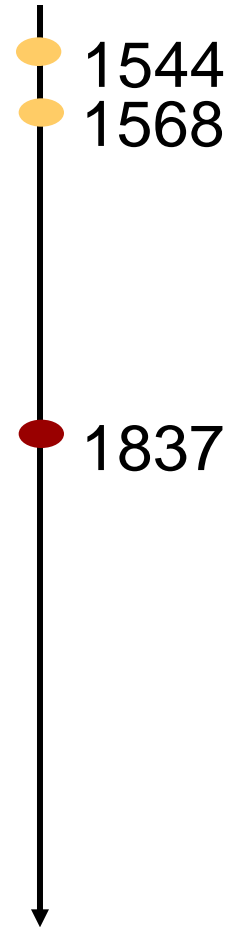

A Brief History of Images



Silicon Image Detector, 1970

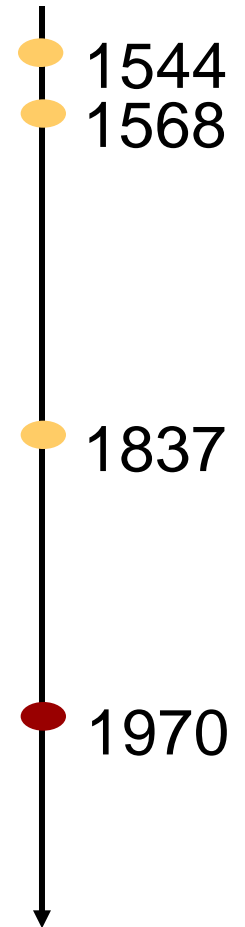

A Brief History of Images



Digital Cameras

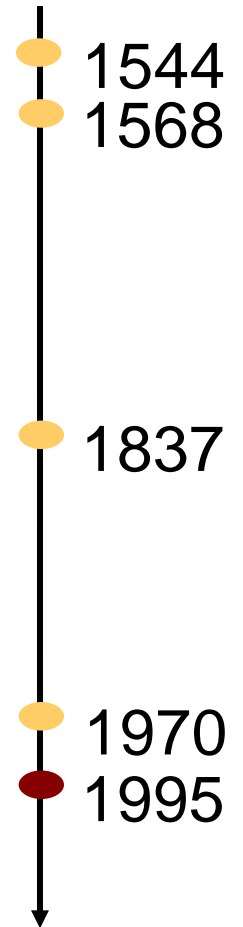

Components of a Computer Vision System

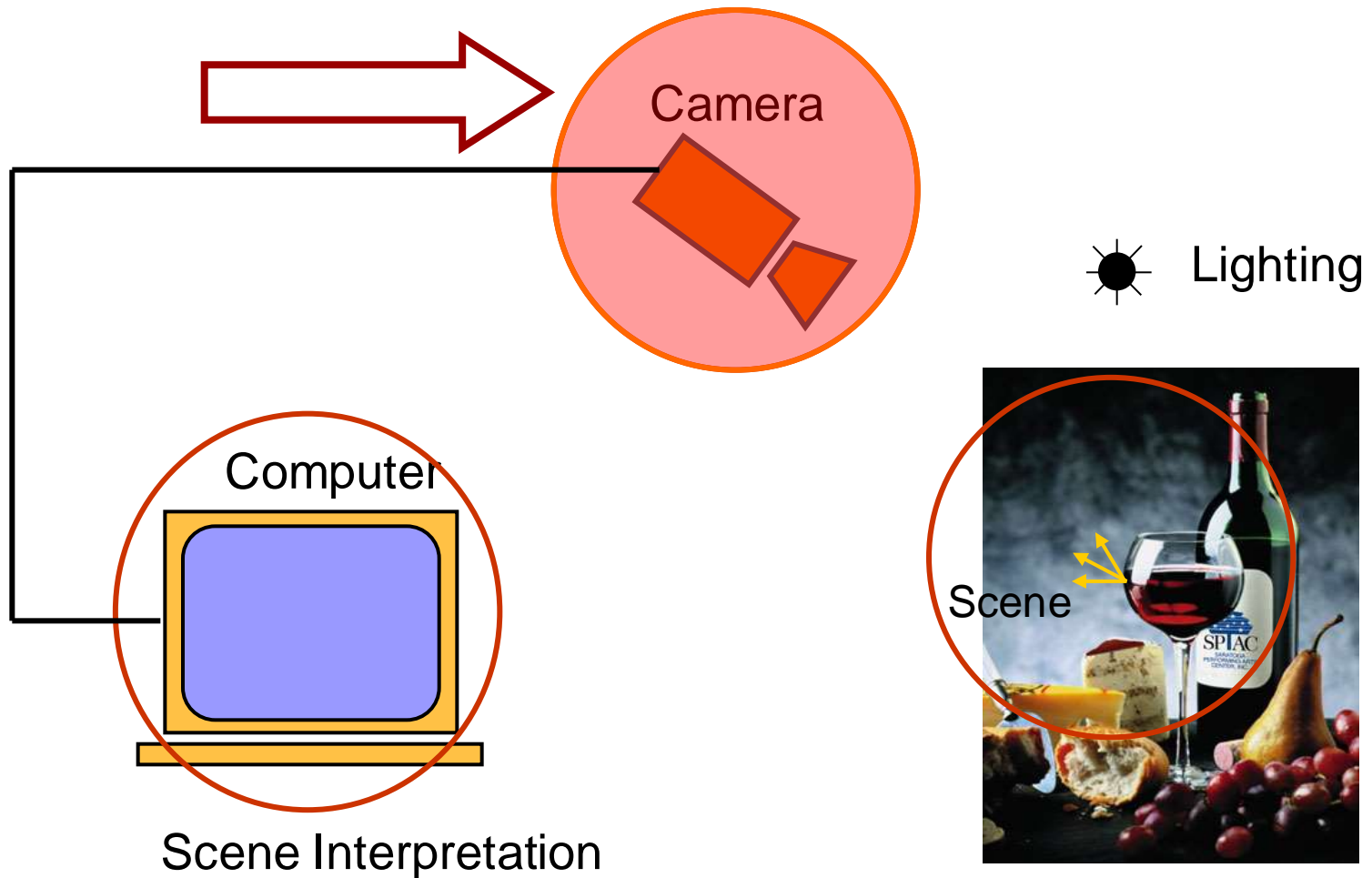

Pinhole and the Perspective Projection

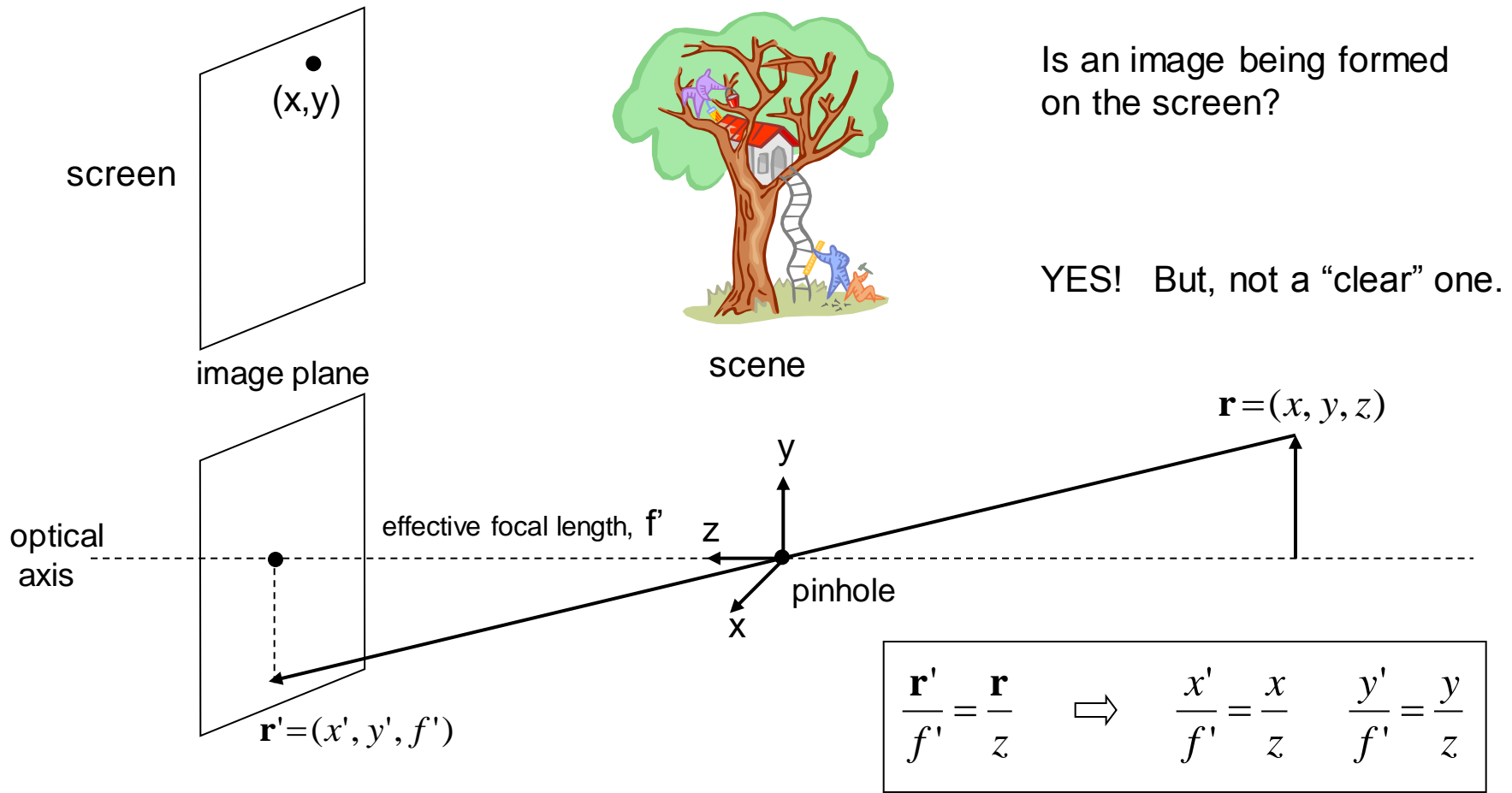

Pinhole Camera

- Basically a pinhole camera is a box, with a tiny hole at one end and film or photographic paper at the other.
- Mathematically: out of all the light rays in the world, choose the set of light rays passing through a point and projecting onto a plane.

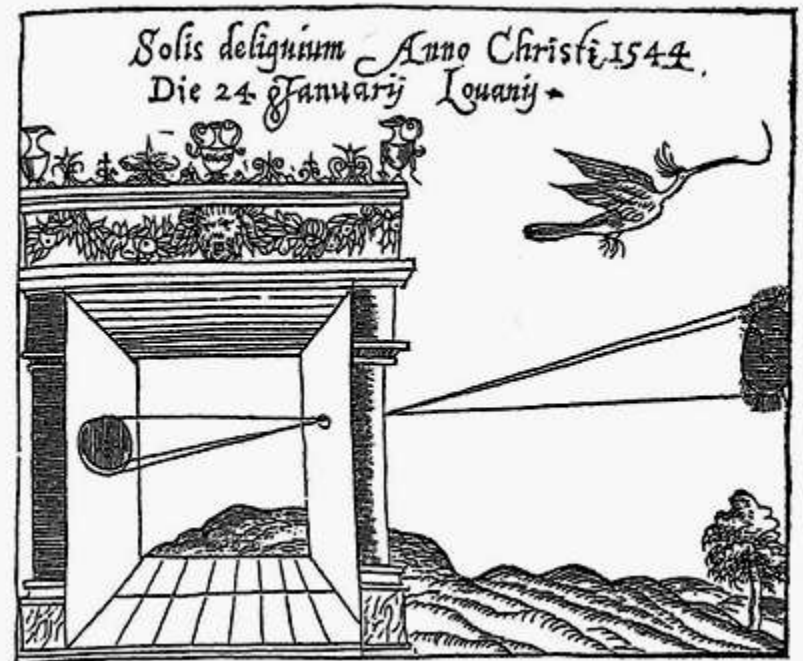

Pinhole Photography



©Charlotte Murray Untitled, 4" x 5" pinhole photograph, 1992



Image Size inversely proportional to Distance

Reading: <http://www.pinholeresource.com/>

Magnification

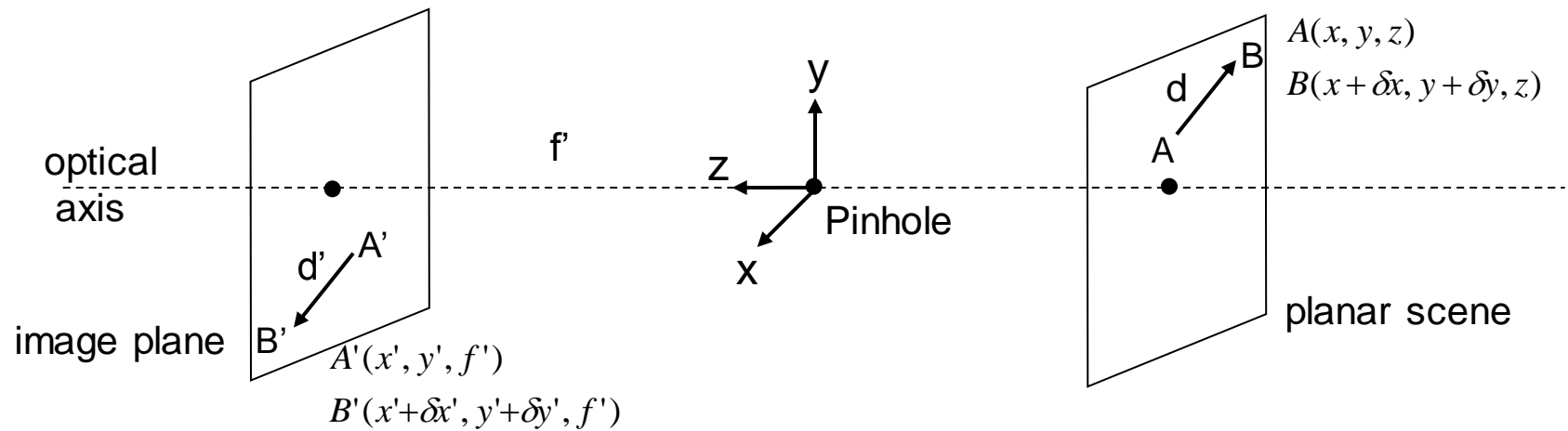

From perspective projection:

$$\frac{x'}{f'} = \frac{x}{z} \quad \frac{y'}{f'} = \frac{y}{z}$$



Magnification:

$$m = \frac{d'}{d} = \frac{\sqrt{(\delta x')^2 + (\delta y')^2}}{\sqrt{(\delta x)^2 + (\delta y)^2}} = \frac{f'}{z}$$

$$\frac{x' + \delta x'}{f'} = \frac{x + \delta x}{z} \quad \frac{y' + \delta y'}{f'} = \frac{y + \delta y}{z}$$

$$\frac{\text{Area}_{\text{image}}}{\text{Area}_{\text{scene}}} = m^2$$

Image Formation using Lenses

- Lenses are used to avoid problems with pinholes.
- Ideal Lens: Same projection as pinhole but gathers more light!

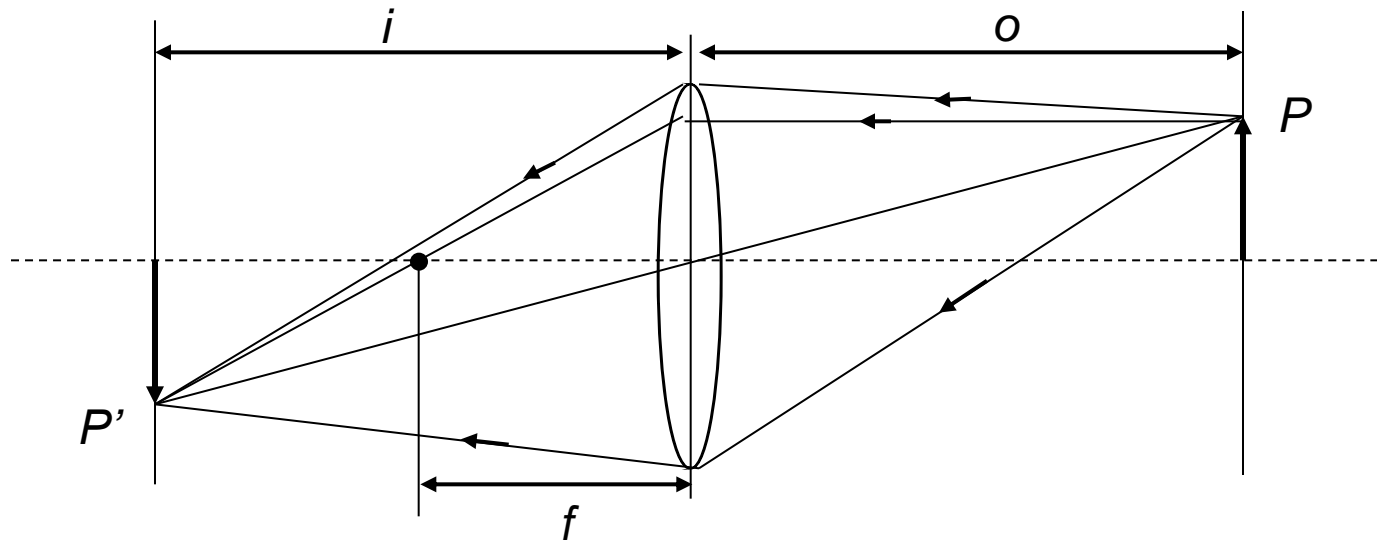

- Gaussian Thin Lens Formula: $\frac{1}{i} + \frac{1}{o} = \frac{1}{f}$
- f is the focal length of the lens – determines the lens's ability to refract light

Focus and Defocus

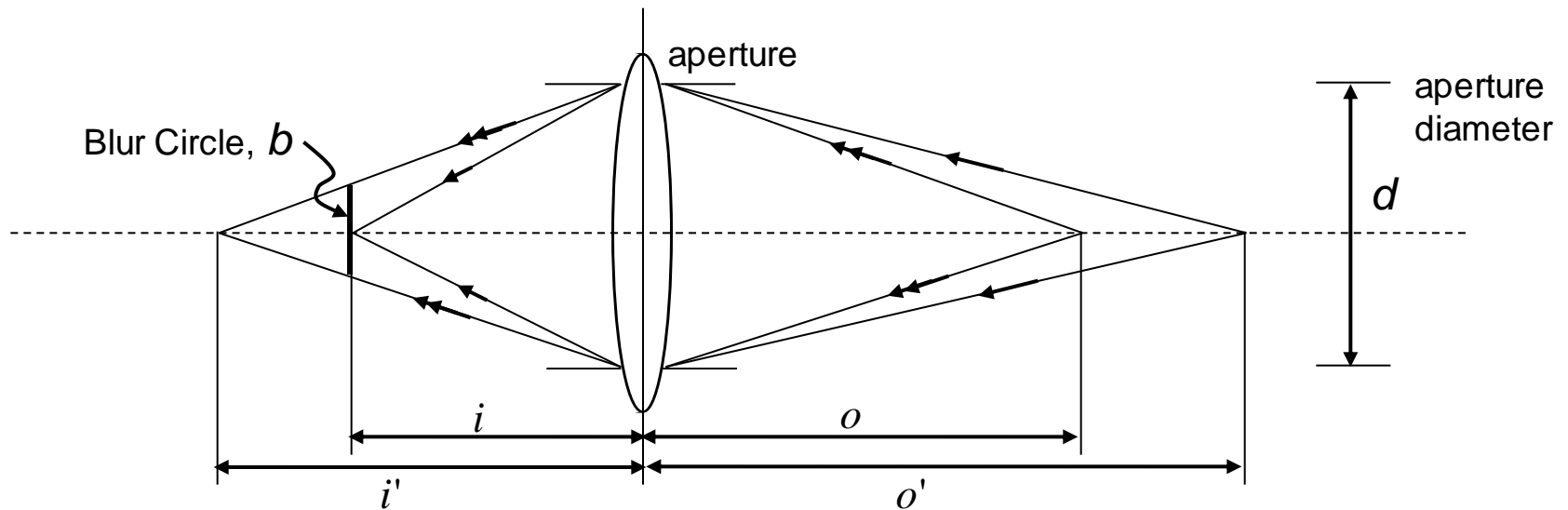

- Gaussian Law:

$$\frac{1}{i} + \frac{1}{o} = \frac{1}{f}$$



$$(i' - i) = \frac{f}{(o' - f)} \frac{f}{(o - f)} (o - o')$$

$$\frac{1}{i'} + \frac{1}{o'} = \frac{1}{f}$$

- In theory, only one scene plane is in focus.

Depth of Field

- Range of object distances over which image is sufficiently well focused.
- Range for which *blur circle* is less than the resolution of the sensor.



http://images.dpchallenge.com/images_portfolio/27920/print_preview/116336.jpg

Chromatic Aberration

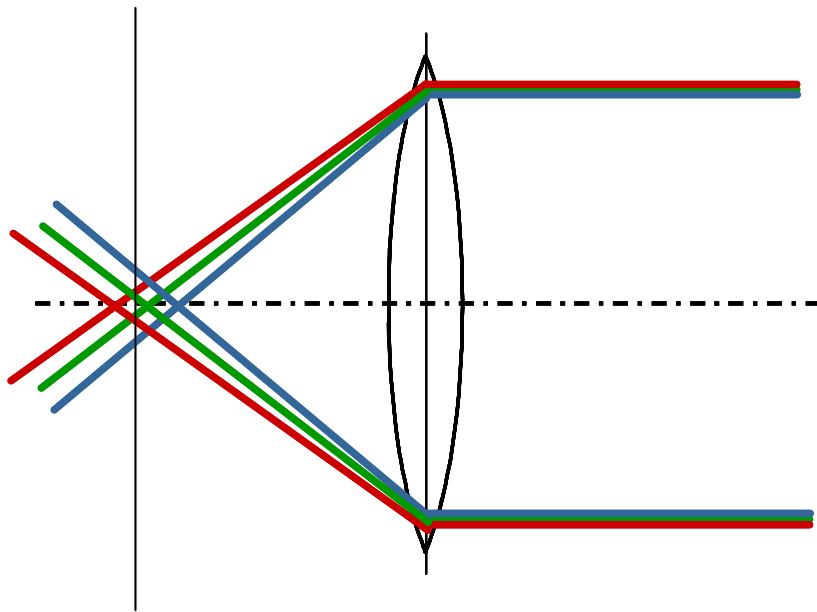

longitudinal chromatic aberration
(axial)

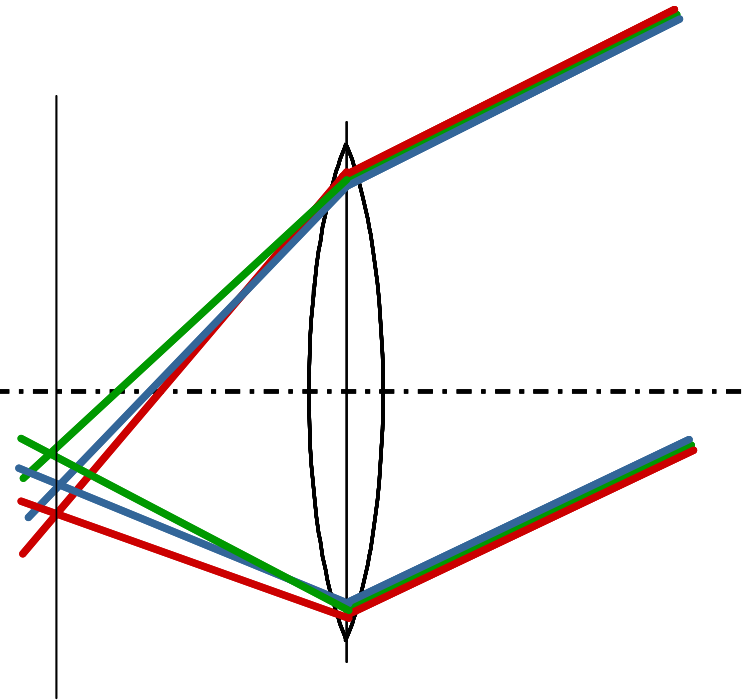

transverse chromatic aberration
(lateral)

Image Sensors

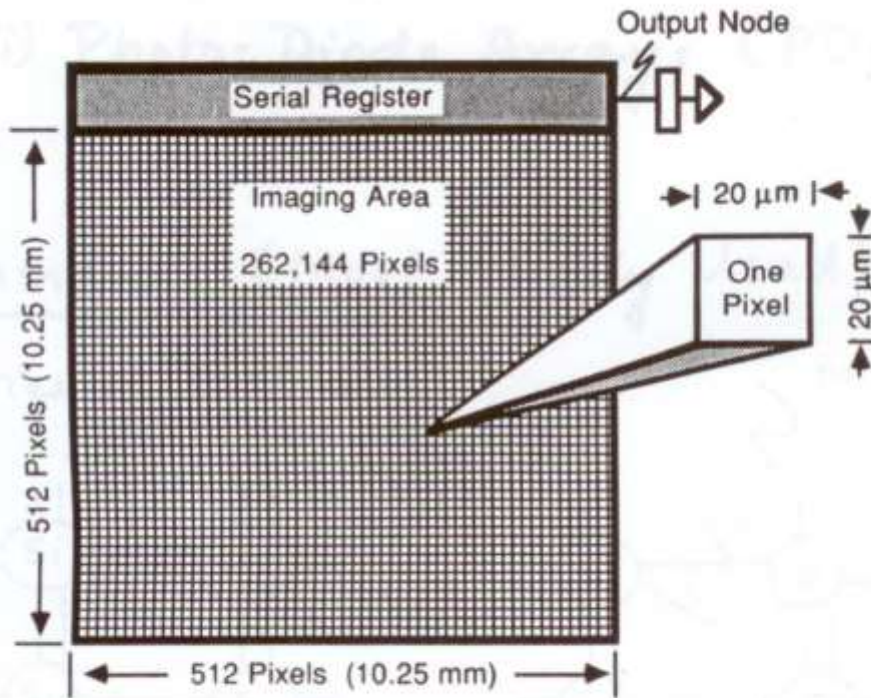

FIG. 4. Typical 512 × 512 CCD.

• Considerations

- Speed
- Resolution
- Signal / Noise Ratio
- Cost

Image Sensors

- Convert light into an electric charge

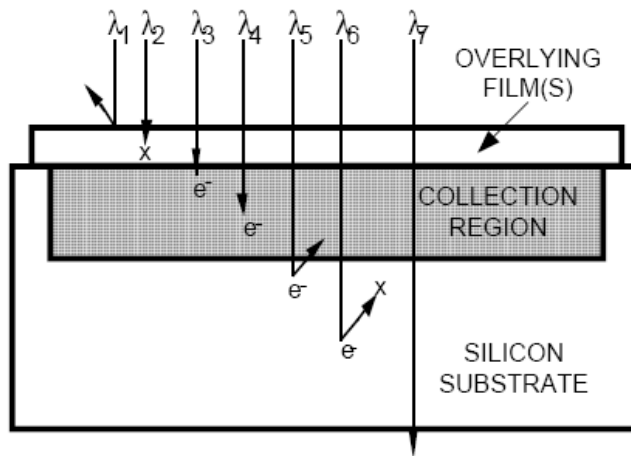

CCD (charge coupled device)

Higher dynamic range

High uniformity

Lower noise

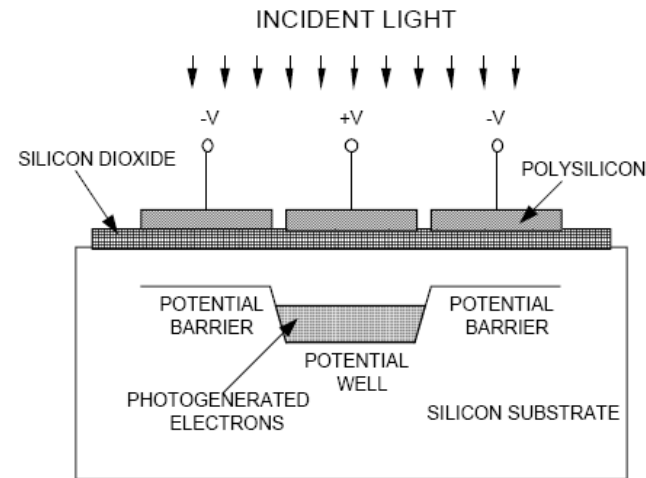
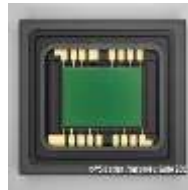

CMOS (complementary metal
Oxide semiconductor)

Lower voltage

Higher speed

Lower system complexity

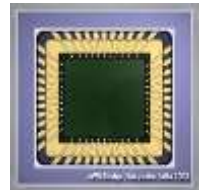

CCD Performance Characteristics

- Linearity Principle: Incoming photon flux vs. Output Signal
 - Sometimes cameras are made non-linear on purpose.
 - Calibration must be done (using reflectance charts)---covered later
- Dark Current Noise: Non-zero output signal when incoming light is zero
- Sensitivity: Minimum detectable signal produced by camera

Sensing Brightness

Incoming light has a spectral distribution $p(\lambda)$

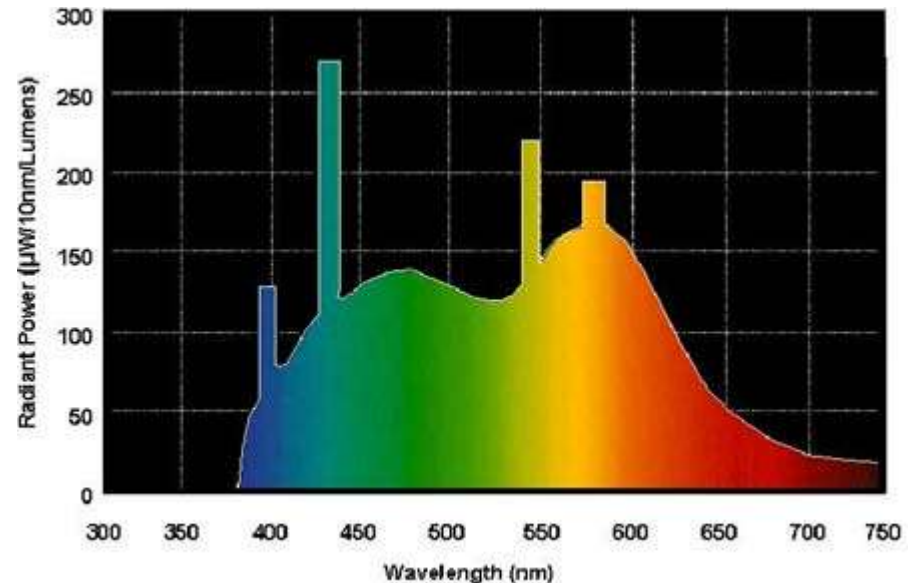
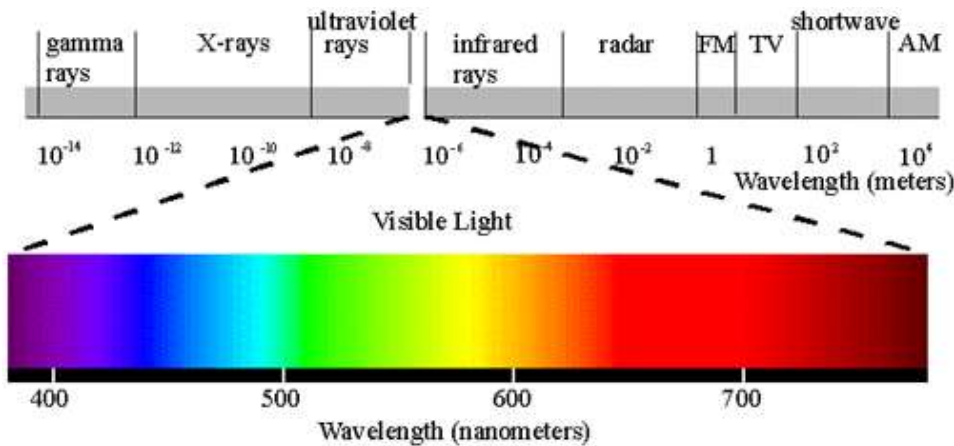

So the pixel intensity becomes

$$I = k \int_{-\infty}^{\infty} q(\lambda)p(\lambda)d\lambda$$

How do we sense colour?

- Do we have infinite number of filters?

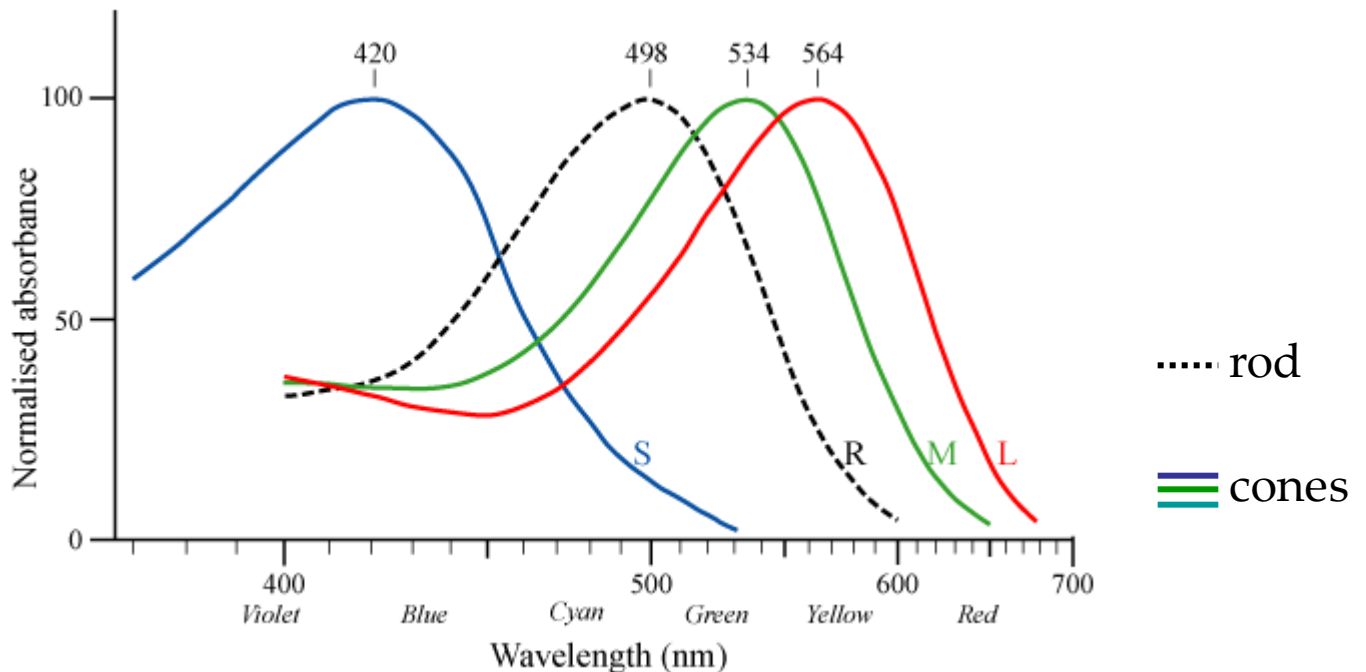

Three filters of different spectral responses

Sensing Colour

- **Tristimulus (trichromatic) values** (I_R, I_G, I_B)

Camera's spectral response functions: $h_R(\lambda), h_G(\lambda), h_B(\lambda)$

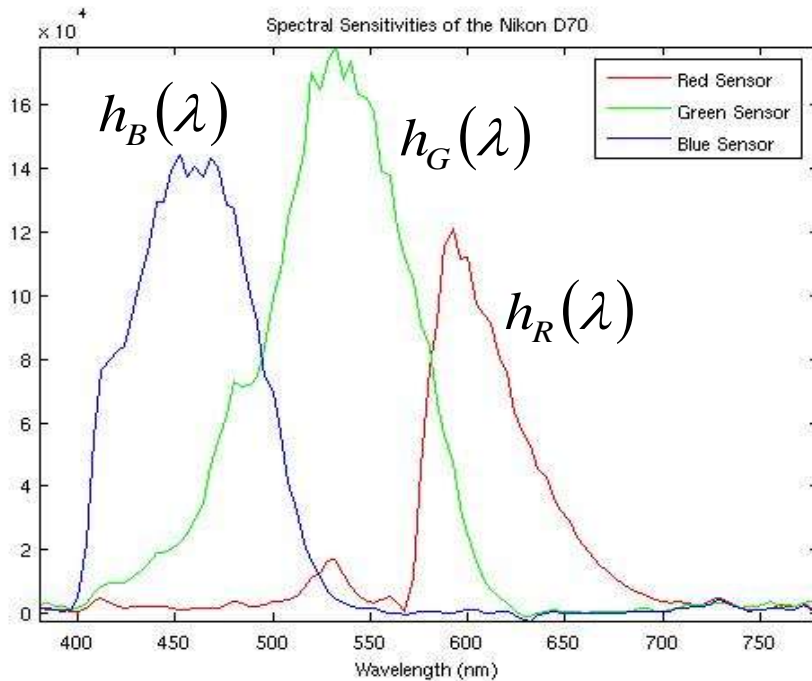

$$I_R = k \int_{-\infty}^{\infty} h_R(\lambda) p(\lambda) d\lambda$$

$$I_G = k \int_{-\infty}^{\infty} h_G(\lambda) p(\lambda) d\lambda$$

$$I_B = k \int_{-\infty}^{\infty} h_B(\lambda) p(\lambda) d\lambda$$

Sensing Colour

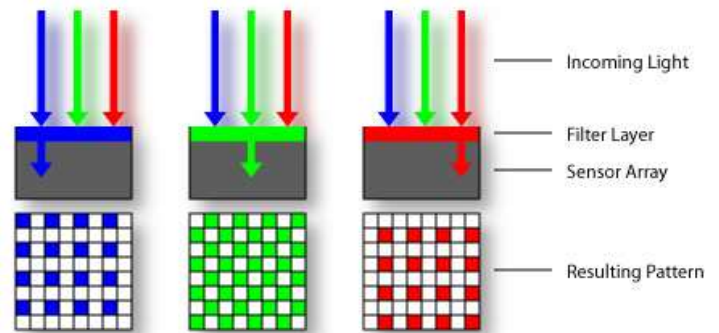
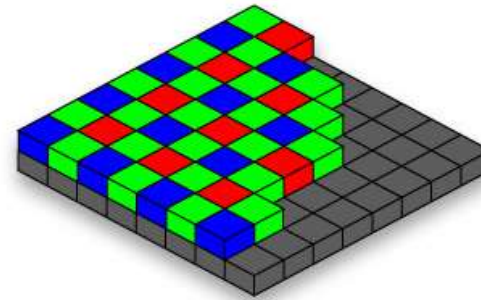
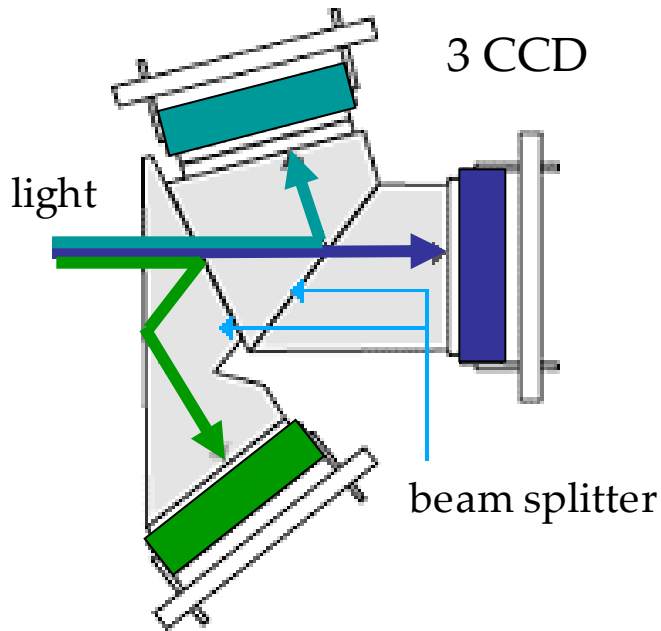

Bayer pattern

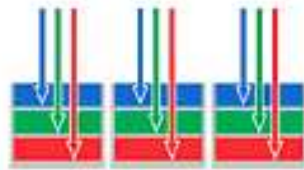

Foveon X3™

Resources

- J.C. Russ – Chapters 1 and 2
- L. Shapiro, and G. Stockman – Chapter 1
- “Color Vision: One of Nature's Wonders” in <http://www.diycalculator.com/sp-cvision.shtml>