

Computer Vision – TP10

Deep Learning Resources and Examples

Miguel Coimbra, Francesco Renna

Outline

- Techniques to reduce overfitting
- Deep learning examples

Outline

- Techniques to reduce overfitting
- Deep learning examples

Generalization

- Deep neural network => high number of parameters (high complexity)
- They require large training datasets
- What can we do when we do not have a large annotated training dataset?

Regularization

- “Regularization is any modification we make to a learning algorithm that is intended to reduce its generalization error but not its training error.”

Weight regularization

- Reduce the generalization error by imposing constraints on the weights
- Modifies the loss function in order to force some structure on the learned weights

$$L'(\theta, \{(x_i, y_i)_i\}) = L(\theta, \{(x_i, y_i)_i\}) + \gamma\Omega(\theta)$$

- Different Ω , different effect on the weights

Weight decay

- **Weight decay: $\Omega(\theta) = \|\theta\|_2^2$**
 - Drives the weights closer to the origin
 - Weight components that do not impact significantly the loss function are decayed

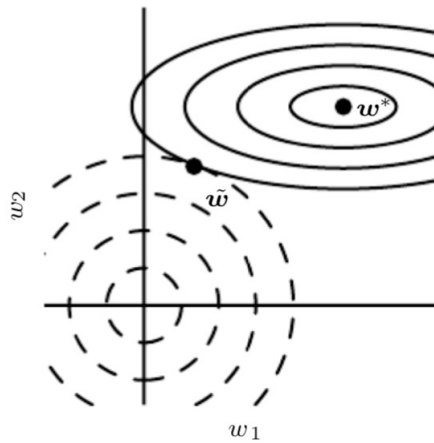

Dropout

- During training, randomly switch off a fraction of the input or hidden units
- It avoids giving too much relevance to some training features
- It approximates bagging and ensemble learning over all sub-models (Monte-Carlo sampling)

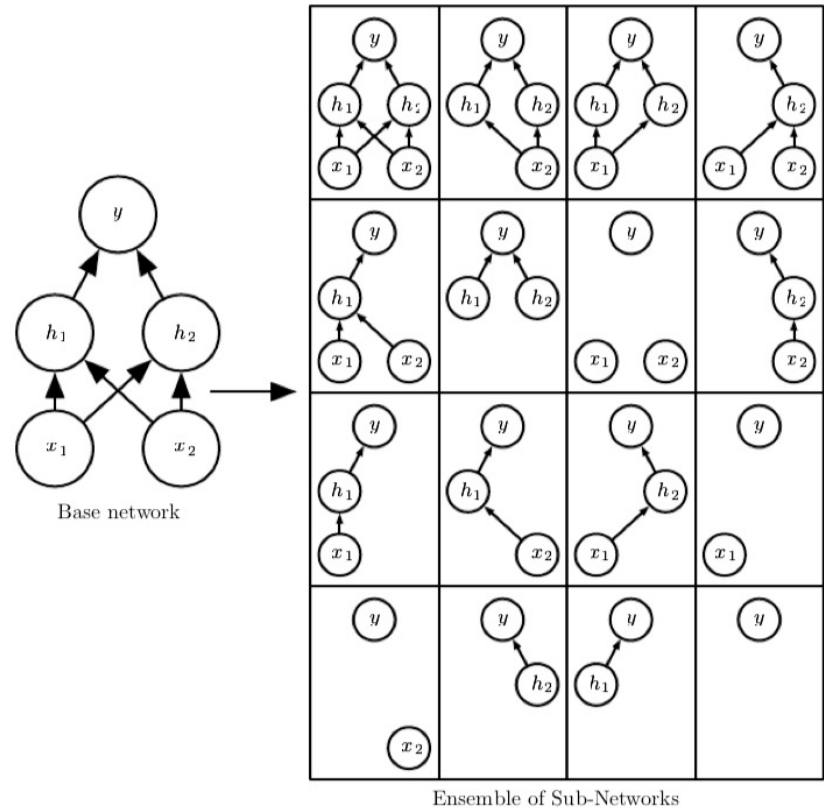

Early stopping

- Retain the model which performs best on the validation set (hopefully, test set too)

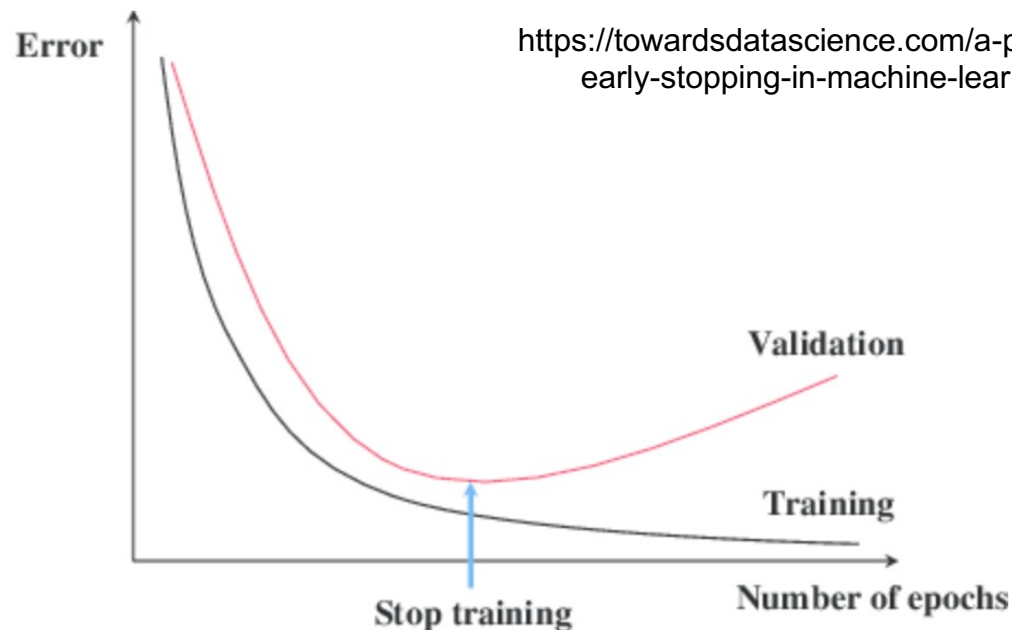

<https://towardsdatascience.com/a-practical-introduction-to-early-stopping-in-machine-learning-550ac88bc8fd>

Early stopping

- Regularization effect: constraint on the number of training steps

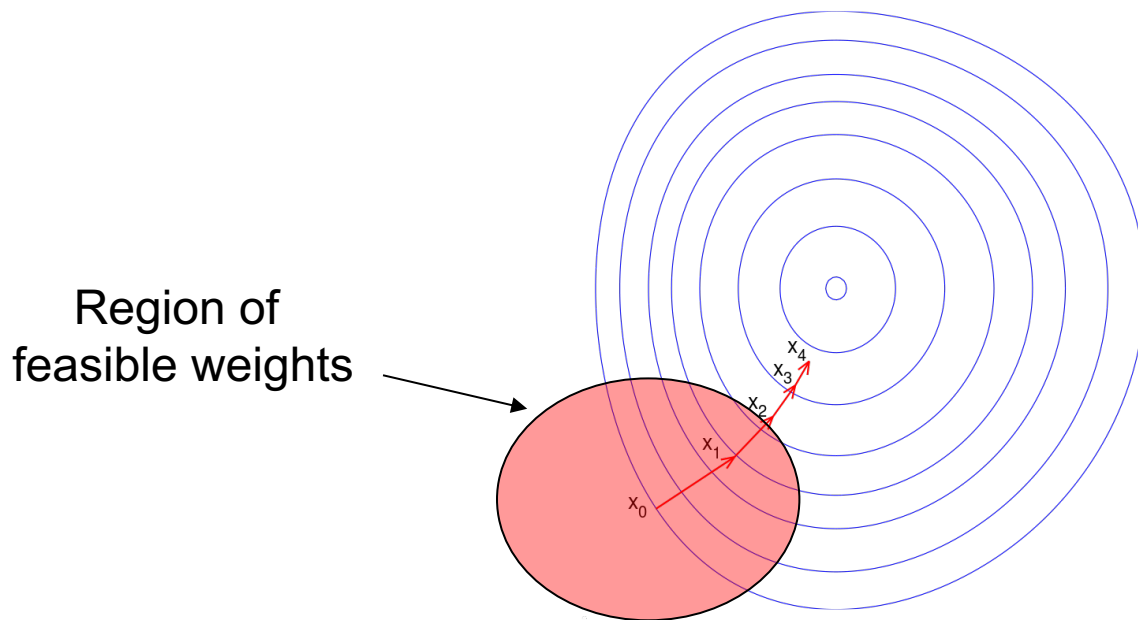

Data augmentation

- Create fake data and add it to the **training dataset** (only training!)
- Especially useful for imaging data
- New data created from transformations of existing training data:
 - Different transformations may be more meaningful in different domains
 - A transformation should not change class meaning

Data augmentation

- **Transformations:**
 - Translating
 - Rotating
 - Cropping
 - Flipping
 - Color space
 - Adding noise
 - Image mixing
 - Generative Adversarial Networks (GANs)
 - Etc.

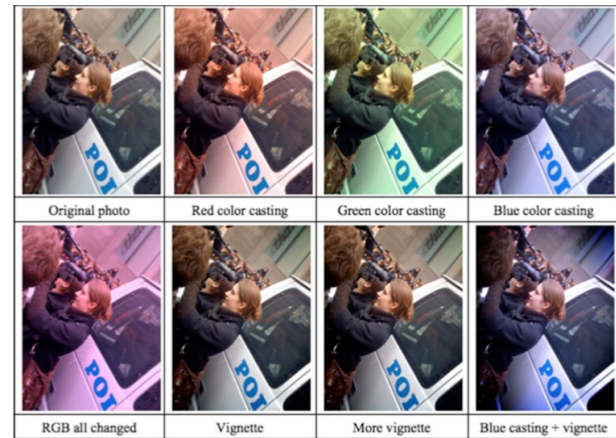
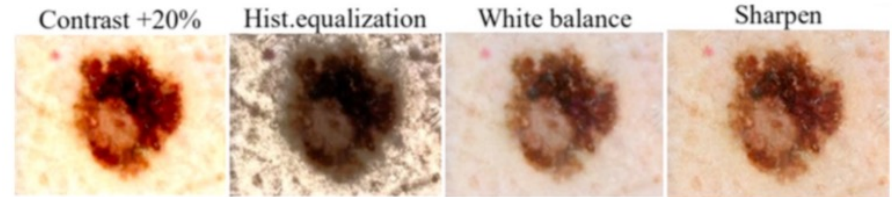

Shorten C, Khoshgoftaar TM. A survey on image data augmentation for deep learning. Journal of Big Data. 2019 Dec;6(1):1-48.

Transfer learning

- **Main idea:**
 - Features to perform a task T1 may be relevant and useful for a different task T2

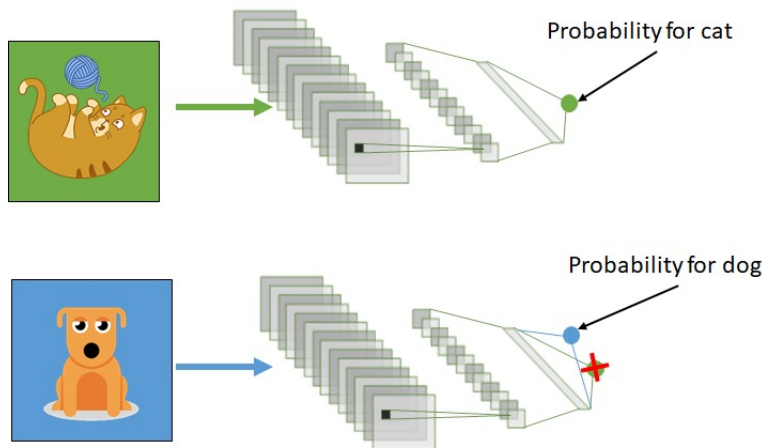

<https://towardsdatascience.com/transfer-learning-3e9bb53549f6>

Transfer learning

- **When is it useful:**
 - Reduced number of training samples for the considered task
 - Large number of training samples for a related task
 - Low-level features could be common to both tasks!
- **Example:**
 - Image classification
 - NNs pre-trained on the ImageNet dataset (~14 million images, ~20,000 categories)

Transfer learning schemes

<https://towardsdatascience.com/a-comprehensive-hands-on-guide-to-transfer-learning-with-real-world-applications-in-deep-learning-212bf3b2f27a>

- **Feature extraction:**

- Keep convolutional layers frozen
- Pre-trained networks works as feature extractor
- Train fully connected/classification layers

- **Fine-tuning:**

- Use pre-trained weights as starting point for training
- Can keep frozen first convolutional layers (mostly edge/geometry detectors)

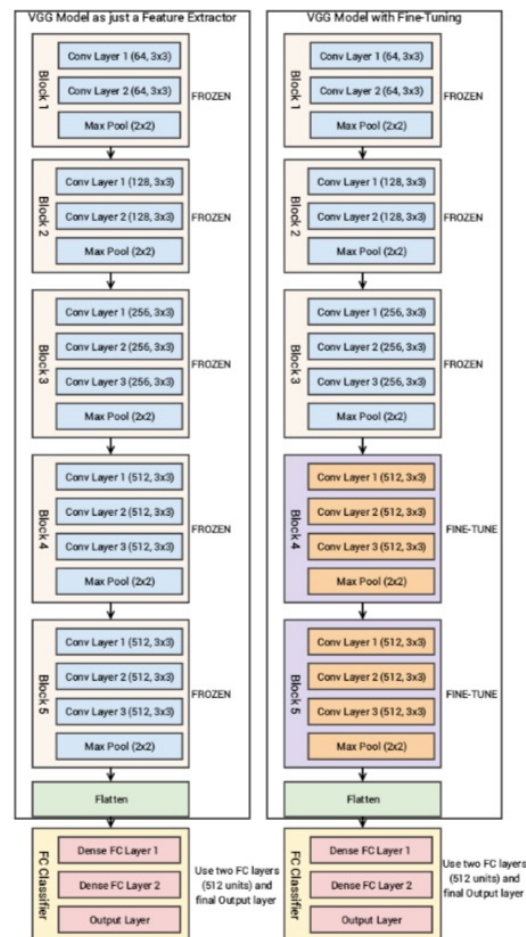

Outline

- Techniques to reduce overfitting
- **Deep learning examples**

Example in Keras

- **Task:**
 - Classify hand-written digits
- **Model:**
 - Convolutional neural network
- **Full code available at:**
 - https://keras.io/examples/vision/mnist_convnet/

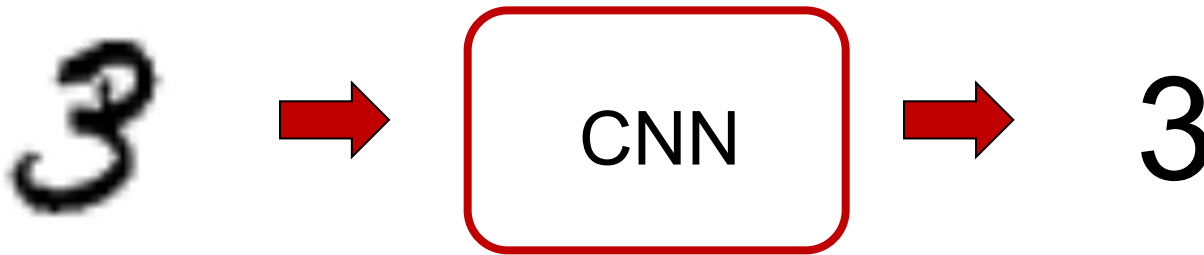

Setup

- Import useful libraries

Useful for processing matrix-like data in Python, and much more...

```
import numpy as np
from tensorflow import keras
from tensorflow.keras import layers
```



Prepare the data

- **Model/data parameters**

```
num_classes = 10  
input_shape = (28, 28, 1)
```

Black and white images = 1 input channel

- **Train and test data**

```
(x_train, y_train), (x_test, y_test) =  
keras.datasets.mnist.load_data()
```

Training labels

Training images: dimensions (60000, 28, 28, 1), “channel-last” ordering

Prepare the data

- **Scale images to [0,1] range**

```
x_train = x_train.astype("float32") / 255  
x_test = x_test.astype("float32") / 255
```

- **One-hot encoding**

```
y_train = keras.utils.to_categorical(y_train, num_classes)  
y_test = keras.utils.to_categorical(y_test, num_classes)
```

E.g., from “3” to $[0 \ 0 \ 1 \ 0 \ 0 \ 0 \ 0 \ 0 \ 0 \ 0]^T$

Build the model - I

- Feature extraction

```
model = keras.Sequential(  
    [  
        keras.Input(shape=input_shape),  
        layers.Conv2D(32, kernel_size=(3, 3), activation="relu"),  
        layers.MaxPooling2D(pool_size=(2, 2)),  
        layers.Conv2D(64, kernel_size=(3, 3), activation="relu"),  
        layers.MaxPooling2D(pool_size=(2, 2)),
```

Number of feature maps

Stride = 1 if omitted

Build the model - II

- **Classification**

```
layers.Flatten(),  
layers.Dropout(0.5),  
layers.Dense(num_classes, activation="softmax"),  
]  
)  
  
model.summary()
```

Reshape feature maps into a vector

50% of nodes are used at during training

Provides a description of the model
with number of parameters

Build the model - III

- Model summary

Model: "sequential"

| Layer (type) | Output Shape | Param # |
|--------------------------------|--------------------|---------|
| conv2d (Conv2D) | (None, 26, 26, 32) | 320 |
| max_pooling2d (MaxPooling2D) | (None, 13, 13, 32) | 0 |
| conv2d_1 (Conv2D) | (None, 11, 11, 64) | 18496 |
| max_pooling2d_1 (MaxPooling2D) | (None, 5, 5, 64) | 0 |
| flatten (Flatten) | (None, 1600) | 0 |
| dropout (Dropout) | (None, 1600) | 0 |
| dense (Dense) | (None, 10) | 16010 |

=====
Total params: 34,826
Trainable params: 34,826
Non-trainable params: 0
=====

Train the model

```
batch_size = 128  
epochs = 15
```

Gradient-based optimizer

```
model.compile(loss="categorical_crossentropy", optimizer="adam",  
metrics=["accuracy"])
```

```
model.fit(x_train, y_train, batch_size=batch_size, epochs=epochs,  
validation_split=0.1)
```

10% of the training data is used for validation

Evaluate the model

```
score = model.evaluate(x_test, y_test, verbose=0)
print("Test loss:", score[0])
print("Test accuracy:", score[1])
```

- **Results**

Test loss: 0.023472992703318596

Test accuracy: 0.9912999868392944

Weight decay in Keras

- Added to each layer

```
l2_model = tf.keras.Sequential([
    layers.Dense(512, activation='elu',
                 kernel_regularizer=regularizers.l2(0.001),
                 input_shape=(FEATURES,)),
    layers.Dense(512, activation='elu',
                 kernel_regularizer=regularizers.l2(0.001)),
    layers.Dense(512, activation='elu',
                 kernel_regularizer=regularizers.l2(0.001)),
    layers.Dense(512, activation='elu',
                 kernel_regularizer=regularizers.l2(0.001)),
    layers.Dense(1)
])
```

Early stopping in Keras

```
tf.keras.callbacks.EarlyStopping(  
    monitor='val_loss', min_delta=0, patience=0, verbose=0,  
    mode='auto', baseline=None, restore_best_weights=False  
)
```

- Then call “callbacks” into `model.fit()`
- Patience = number of epochs with no improvement after which training is stopped
- Min_delta = minimum change
- Restore_best_weights = keep best model

Transfer learning Keras

- Load a pre-trained model

```
# Create the base model from the pre-trained model MobileNet V2
IMG_SHAPE = IMG_SIZE + (3,)
base_model = tf.keras.applications.MobileNetV2(input_shape=IMG_SHAPE,
                                               include_top=False,
                                               weights='imagenet')
```

- Feature extractor: `base_model.trainable = False`
- Fine-tuning: `base_model.trainable = True`
- Then add a classification head

Resources

- I. Goodfellow, Y. Bengio, and A. Courville. Deep learning. Cambridge: MIT press, 2016.
 - Chapter 7 – “Regularization for deep learning”
- <https://www.tensorflow.org/tutorials/keras>
- <https://www.tensorflow.org/tutorials/images>